

SIEMENS

Ingenuity for life



SINAMICS V90

The performance-optimized and
easy-to-use servo drive system

[siemens.com/sinamics-v90](https://www.siemens.com/sinamics-v90)

SINAMICS V90 and SIMOTICS S-1FL6

Optimized servo drive solution
for motion control applications

Content

Servo drive system overview	03
Servo drive system advantages	05
SINAMICS V90 servo drive system in the automation environment	10
SINAMICS V-ASSISTANT engineering tool	10
SINAMICS V90 technical data and control features	12
System overview and connection diagrams	15
SIMOTICS S-1FL6 technical data and torque-speed characteristics	18
Step-by-step selection	2A
SINAMICS V90 and SIMOTICS S-1FL6 ordering information	3A
SINAMICS V90 and SIMOTICS S-1FL6 dimensions and mounting clearances	6A

Servo drive system

The performance-optimized, user-friendly servo drive system comprises a SINAMICS V90 servo drive and a SIMOTICS S-1FL6 servomotor. Different frame sizes and motor shaft heights cover a wide range of applications for operation on single- and three-phase line supplies. There are eight servo drive frame sizes and seven motor shaft heights with power ratings ranging from 0.05 to 7.0 kilowatts, to realize a wide range of applications, with the focus on dynamic motion and processing – for example positioning, transporting and winding. In addition to operation in the TIA Portal V14 with the new SIMATIC S7-1500 T-CPU Advanced Controller, the servo drive system is also suitable for use with the SIMATIC S7-1500 Advanced Controller and the SIMATIC S7-1200 Basic Controller.



Pulse train version (PTI)

PROFINET version (PN)

SINAMICS V90 servo drive

SINAMICS V90 can be integrated into a wide range of applications, either using the pulse train version (pulse/direction, analog, USS/Modbus RTU) or the product version with integrated PROFINET interface.

The SINAMICS V90 pulse train version features internal positioning, positioning with pulse train as well as speed and torque control modes. SINAMICS V90 PROFINET version is equipped with an integrated PROFINET interface for linking the drive to an automation system via PROFIdrive profile. With integrated real-time auto tuning and automatic suppression of machine resonances, the system automatically optimizes itself to achieve high dynamic performance and smooth operation.

SIMOTICS S-1FL6 servomotor

SIMOTICS S-1FL6 servomotors are naturally cooled, permanent-magnet synchronous motors where the heat is dissipated through the motor surface. The motors can be simply and quickly installed using the full thread and quick-release connectors. They have a 300 percent overload capability and can be combined with SINAMICS V90 servo drive to create a powerful servo system with a high degree of functionality.

Highlights of the SINAMICS V90 and SIMOTICS S-1FL6 servo drive system:

Optimized servo performance

- Advanced one-button tuning and real-time auto tuning enables machines to achieve a high dynamic performance
- Automatic suppression of machine resonances
- 1 MHz high-frequency pulse train input
- Different encoder types to address the requirements of your applications

Cost effective

- Integrated control modes: Pulse train positioning, internal positioning with traversing block or Modbus, speed and torque control modes
- Integrated internal positioning function
- Integrated braking resistor in all frame sizes
- Integrated holding brake switch (for the 400 V version), no external relay necessary

Easy to use

- Simple connection to a control system
- Easy, all from a single source
- Easy servo tuning and machine optimization
- Easy commissioning with SINAMICS V-ASSISTANT
- Parameter cloning
- Easy integration via PTI, PROFINET, USS, Modbus RTU

Reliable operation

- High-quality motor bearings
- All motors have IP65 degree of protection and are equipped with oil seal
- Integrated Safe Torque Off (STO)

Power, performance, typical applications

SINAMICS V90 servo drive system 1AC/3AC 200 V... 240 V Low Inertia for high dynamic performance		SINAMICS V90 servo drive system 3AC 380 V... 480 V High Inertia for smooth operational performance	
SINAMICS V90 servo drive		SINAMICS V90 servo drive	
Line supply and power:	1AC 200 V ... 240 V (–15%/+10%), 0.05 kW ... 0.75 kW 3AC 200 V ... 240 V (–15%/+10%), 0.05 kW ... 2 kW	Line supply and power:	3AC 380 V ... 480 V (–15%/+10%), 0.4 kW ... 7 kW
Pulse train (PTI) version Control mode:	Positioning with pulse train, internal positioning, speed, torque	Pulse train (PTI) version Control mode:	Positioning with pulse train, internal positioning, speed, torque
PROFINET (PN) version Control mode:	Speed control via PROFINET with PROFIdrive profile**	PROFINET (PN) version Control mode:	Speed control via PROFINET with PROFIdrive profile**
Degree of protection:	IP20	Degree of protection:	IP20
SIMOTICS S-1FL6 servomotor		SIMOTICS S-1FL6 servomotor	
4 shaft heights:	20 mm, 30 mm, 40 mm, 50 mm	3 shaft heights:	45 mm, 65 mm, 95 mm
Rated torque:	0.16 Nm up to 6.37 Nm	Rated torque:	1.27 Nm up to 33.40 Nm
Rated/max. speed:	3000 rpm/5000 rpm	Rated/max. speed:	2000 rpm/3000 rpm
Encoder:	Incremental encoder TTL 2500 ppr***; Absolute encoder single-turn 21-bit*	Encoder:	Incremental encoder TTL 2500 ppr; Absolute encoder 20-bit + 12-bit multi-turn
Degree of protection:	IP65, natural cooling	Degree of protection:	IP65, natural cooling
Additional advantages:		Additional advantages:	
<p>High dynamic performance: High acceleration for shorter cycle times as a result of the very low moment of inertia</p> <p>High speed: Maximum speed up to 5000 rpm can increase machine productivity</p> <p>Compact size: The reduced motor length/height compared to High Inertia variants and compact drive size can address critical mounting requirements</p>		<p>Smooth operation: Higher torque accuracy and low speed ripple as a result of the higher moment of inertia ensures a better product quality</p> <p>Robust design: High-quality metal connector and standard motor oil seal can withstand harsh environment</p> <p>Sufficient torque output: Wide range of rated torques up to 33.4 Nm</p>	
Application examples		Application examples	
Electronic assembly industry, for example	<ul style="list-style-type: none"> • Pick and place machine • Stencil cutting machine • PCB assembly machine • IC handling machine • Chip sorting machine • Bonding machine 	Metal forming machinery, for example	<ul style="list-style-type: none"> • Punching machine • Engraving machine • Edging press
Converting/printing industry, for example	<ul style="list-style-type: none"> • Labeling machine • Slitter machine • Laminating/coating machine • Screen printing machine 	Converting/printing industry, for example	<ul style="list-style-type: none"> • Winders • Slitter machine • Laminating/coating machine • Screen printing machine • Wire drawing machine
Packaging industry, for example	<ul style="list-style-type: none"> • Filling and sealing machine • Blister machine (pharmaceutical packaging) • Bag packing machine 	Packaging industry, for example	<ul style="list-style-type: none"> • Filling machine • Blister machine (pharmaceutical packaging) • Bag packing machine
Material handling machinery, for example	<ul style="list-style-type: none"> • Automatic palletizers 	Material handling machinery, for example	<ul style="list-style-type: none"> • Storage and warehouse systems • Conveyor systems

* Absolute encoder single-turn 21-bit available in the 2nd half of 2016

** Position and speed control in combination with a motion function (TO axis) of SIMATIC S7-1500 T-CPU / S7-1500 / S7-1200

*** For very low speed, high accuracy or high dynamic application TTL encoder is not recommended

Cost effective

Many integrated functions to reduce machine costs

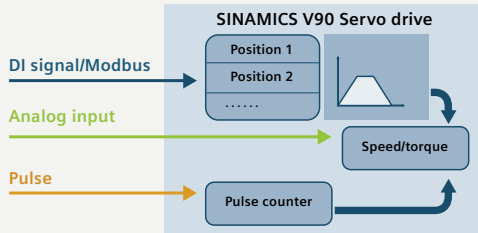
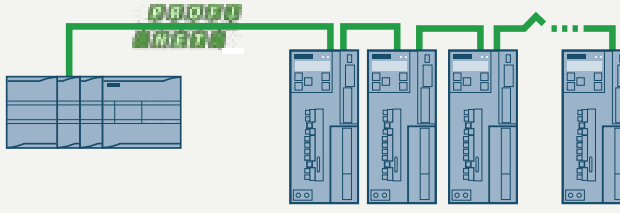
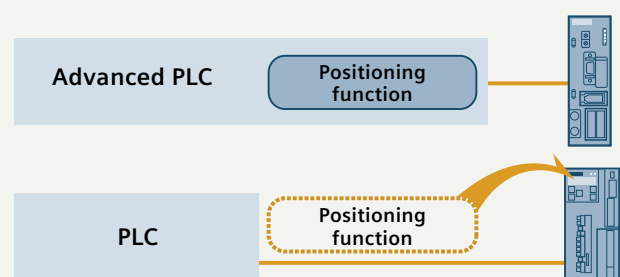
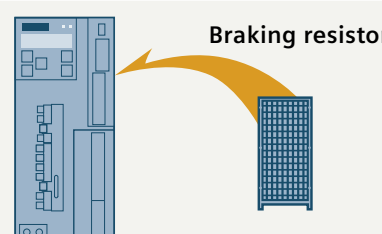
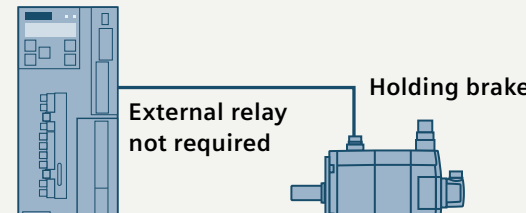
<p>Integrated control modes</p> 	<p style="text-align: right;">Pulse train (PTI) <input checked="" type="checkbox"/> PROFINET (PN) <input type="checkbox"/></p> <p>Pulse train input position control mode (PTI), internal position control mode (IPos) with traversing block or Modbus, speed control mode and torque control are all integrated in the SINAMICS V90.</p> <p>The drive has various integrated control modes to address a wide range of applications.</p>
<p>Integrated PROFINET – the industrial Ethernet standard for automation</p> 	<p style="text-align: right;">Pulse train (PTI) <input type="checkbox"/> PROFINET (PN) <input checked="" type="checkbox"/></p> <p>SINAMICS V90 PROFINET version features a PROFINET interface, enabling real-time transmission of user/process data and diagnostic data with a single cable.</p> <p>This solution offers wide-ranging functions with reduced complexity.</p>
<p>Integrated positioning function</p> 	<p style="text-align: right;">Pulse train (PTI) <input checked="" type="checkbox"/> PROFINET (PN) <input type="checkbox"/></p> <ul style="list-style-type: none"> • Positioning function is integrated in the drive. Target positions and respective speeds can be stored in the drive during commissioning or changed via communication. • Absolute or relative positioning • Rotary or linear axes • Referencing in the drive <p>Point-to-point positioning possible using a PLC without positioning functionality.</p>
<p>Integrated braking resistor for all frame sizes</p> 	<p style="text-align: right;">Pulse train (PTI) <input checked="" type="checkbox"/> PROFINET (PN) <input checked="" type="checkbox"/></p> <p>All frame sizes have an integrated braking resistor to dissipate the regenerative power for fast braking.</p> <p>Most applications can be realized without an additional braking resistor.</p>
<p>Integrated holding brake switch (SINAMICS V90, 400 V version)</p> 	<p style="text-align: right;">Pulse train (PTI) <input checked="" type="checkbox"/> PROFINET (PN) <input checked="" type="checkbox"/></p> <p>Integrated holding brake switch – the brake can be directly connected to the drive when a motor with holding brake is used.</p> <p>Holding brake can be connected without requiring an external relay (only for SINAMICS V90, 400 V version).</p>

Optimized servo performance

Quick, smooth and precise positioning

Advanced one-button tuning and real-time auto tuning

Pulse train (PTI) PROFINET (PN)

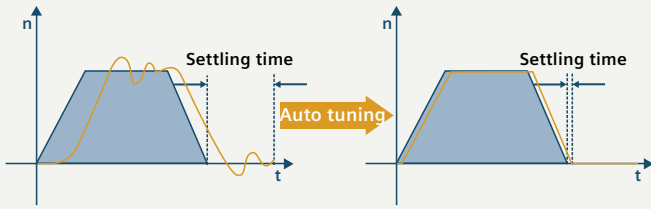

Control loop parameters are optimized automatically. One-button tuning can be used when commissioning. **This allows machines to achieve a high dynamic performance and smooth operation in a wide range of applications.**

Automatic suppression of machine resonances

Pulse train (PTI) PROFINET (PN)

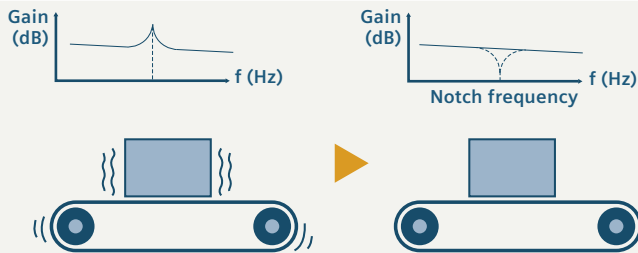

When this function is activated the drive identifies mechanical resonance frequencies and automatically suppresses these using a filter. Vibration and noise during operation are reduced. **This ensures a high dynamic response of the machine while reducing machine vibration levels.**

Sufficient encoder resolution and high data transfer rates

Pulse train (PTI) PROFINET (PN)

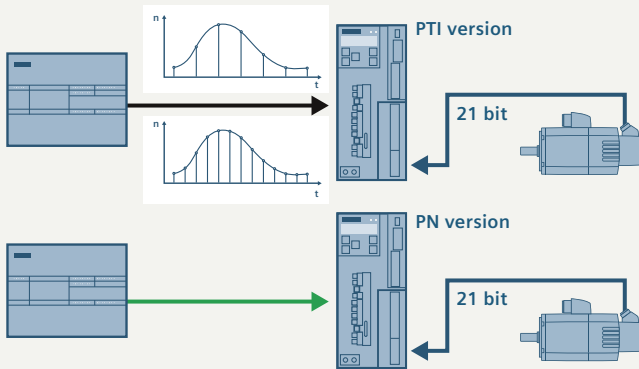

The encoder is available up to 21-bit resolution (approx. 2.1 billion pulses per motor rotation).

The command:

- Signaling rate up to 1 MHz (pulse train version)
- 100 Mbit/s transfer rate (PROFINET version)

Allows machines to achieve a high positioning accuracy with low speed ripple.

Optimized system performance

Pulse train (PTI) PROFINET (PN)

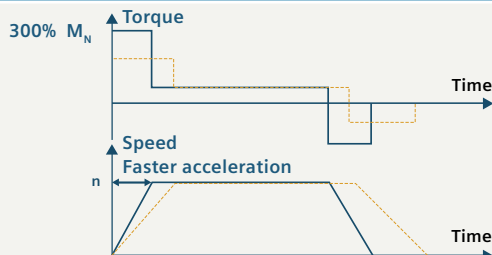

- 300% overload capability of drive and motor
- Low motor torque ripple
- Motor and drive are perfectly harmonized

Fast acceleration and braking while maintaining smooth operation to ensure high machine productivity.

Easy to use

Simple tuning and quick commissioning

Easy servo tuning and machine optimization Pulse train (PTI) PROFINET (PN)

Commissioning

Tuning

Optimizing

The system can be automatically optimized using the auto tuning function and automatic suppression of machine resonances.

Simply plug & play, no in-depth servo know-how required.

Easy commissioning using the SINAMICS V-ASSISTANT engineering tool Pulse train (PTI) PROFINET (PN)

Graphic user interface guides the user when setting application-specific parameters; intuitive drive and motor status check; integrated trace and measuring functionality.

SINAMICS V-ASSISTANT makes commissioning and diagnostics quick and easy.

<https://www.siemens.com/sinamics-v-assistant>

Simple connection to a control system Pulse train (PTI) PROFINET (PN)

- Two-channel pulse train for position setpoint, one exclusively for 5 V differential (RS 422 standard), one for 24 V single-ended signal (for pulse train version)
- Standard RS 485 interface supports USS and Modbus RTU (pulse train version)
- Industrial Ethernet standard PROFINET with PROFIdrive (PROFINET version)

Standard interface makes it easy to connect the drive with PLCs and motion controller.

Easy, all from a single source Pulse train (PTI) PROFINET (PN)

- Predefined drive/motor bundles and accessories, easy to select
- Tested with SIMATIC PLC / HMI and ready-to-run application examples for connecting a SINAMICS V90 drive to a controller
- Different application examples can be downloaded free of charge from the Online Support Portal (see also page 11)

Parameter cloning Pulse train (PTI) PROFINET (PN)

Commissioning

SINAMICS V90 servo drives are equipped with a standard SD card slot (400 V version) and a Micro SD card slot (200 V version), so that parameter settings can be easily transferred between drive devices.

Efficient commissioning of machine series.

Reliable operation

Robust in design and a safe choice

Suitable for harsh environments

Pulse train (PTI) PROFINET (PN)

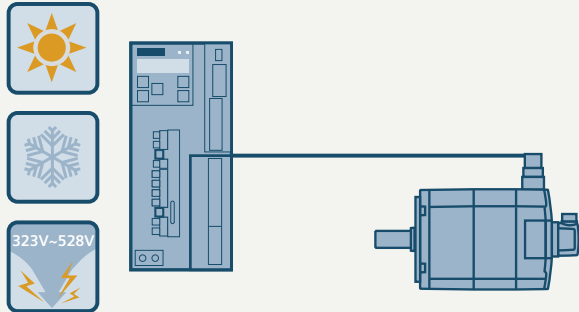

- Wide range of line voltages:
 - 200 V ... 240 V 1AC / 3AC (–15% / +10%)
 - 380 V ... 480 V 3AC (–15% / +10%)
- Coated PCB increases robustness of the drive to cope with harsh environments
- Motor is equipped with high-quality bearings

High degree of motor protection

Pulse train (PTI) PROFINET (PN)

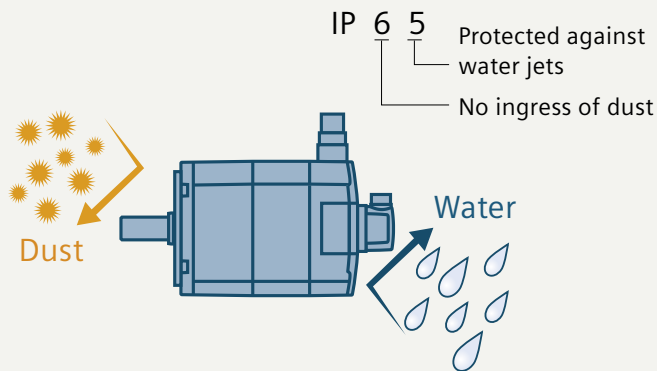

- SIMOTICS S-1FL6 motors have degree of protection IP65 as standard
- Oil seal at shaft end as standard
- High-quality metal motor connector (High inertia motors)

Integrated STO safety function (Safe Torque Off)

Pulse train (PTI) PROFINET (PN)

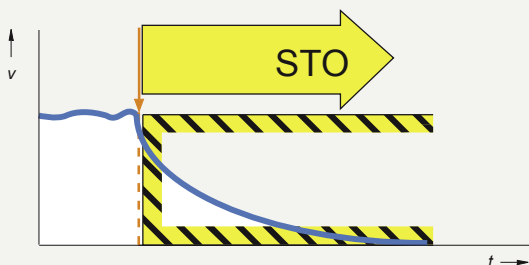

The STO function is a standard feature of all SINAMICS V90 servo drives. This function prevents the motor from moving unexpectedly and complies with safety standard SIL 2 according to EN 61508 resp. PL d, Cat 3 according to EN ISO 13849. This safety functionality can be realized without additional components (activation only via terminals of SINAMICS V90, not supported via PROFINET/PROFIsafe).



Integrated and innovative

Support when selecting, commissioning and operating: powerful software tools

Industry Mall



The Industry Mall supports you with:

- Selecting products, services and training courses

The Industry Mall supplies you with:

- The product selection of the complete and up-to-date Siemens automation and drive technology product spectrum
- System configuration, DT Configurator
<https://siemens.com/dt-configurator>
- Download of CAX data, data sheets and schematic diagrams
- Online shopping cart orders
- Price and order overview
- Availability check and order tracking

Link to Internet page:

<https://mall.industry.siemens.com>

SINAMICS V-ASSISTANT

Easy-to-use engineering tool for commissioning and diagnostics



User task-centric design for prompted machine commissioning

A PC with installed SINAMICS V-ASSISTANT software tool can be connected to SINAMICS V90 via a standard USB port. It is used for setting parameters, test operation, troubleshooting – and has powerful monitoring functions.

SINAMICS V-ASSISTANT can be downloaded free of charge from the SINAMICS V90 Internet page.

Link to Internet page:

<https://siemens.com/sinamics-v90>

Complete motion control solutions from Siemens

SINAMICS V90 System and SIMATIC – Siemens offers comprehensive solutions from a single source for general motion control applications. We can provide you with highly efficient systems, especially through the optimum interaction between SIMATIC control technology and SINAMICS drive technology with our “SINAMICS Application Examples.”

Siemens application examples comprise the following	Benefits for the customer
<ul style="list-style-type: none"> • Ready-to-run application example including wiring diagram and parameter description • Sample configuration to connect SINAMICS V90 drives to the appropriate SIMATIC controller – this includes hardware and software, a corresponding wiring example, installation instructions for the S7 project provided, drive parameterization and a HMI sample project 	<ul style="list-style-type: none"> • An operational project is configured properly • A motor is quickly made operational • Basis for a customer-specific configuration • TIA advantages are optimally leveraged • Can be downloaded free of charge via the Online Support Portal: https://siemens.com/sinamics-applications

Example: Positioning with SINAMICS V90 using pulse/direction interface and SIMATIC S7-1200 control via HMI

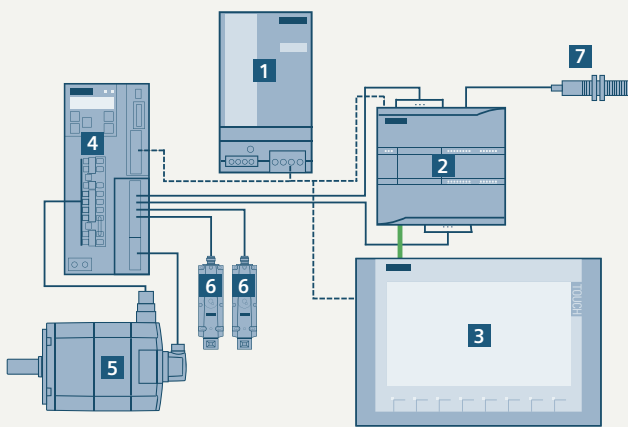

- 1 SITOP PSU100L power supply
- 2 SIMATIC S7-1200, CPU 1217C
- 3 KTP700 Basic
- 4 SINAMICS V90
- 5 SIMOTICS S-1FL6 servomotor
- 6 Mechanical limit switch
- 7 Inductive reference cam

Task
A SINAMICS V90 servo drive is to control a SIMOTICS S-1FL6 servomotor. A SIMATIC S7-1200 is to be used to select the following functions via a touch panel.

Solution
The SINAMICS V90 is controlled via the pulse/direction interface (PTI) of the SIMATIC S7-1200. Technology objects are employed along with the PLCopen motion control standard to control the axis. The move commands are entered at a SIMATIC Basic Panel, which communicates with the SIMATIC controller via Ethernet.

Link to Internet page:
<https://siemens.com/sinamics-applications>

Technical data – SINAMICS V90 servo drive

Line supply		200 ... 240 V 1AC/3AC							
Article No.	Pulse train: 6SL3210-5F PROFINET: 6SL3210-5F	B10-1UA0 B10-1UFO	B10-2UA0 B10-2UFO	B10-4UA1 B10-4UF1	B10-8UA0 B10-8UFO	B11-0UA1 B11-0UF1	B11-5UA0 B11-5UFO	B12-0UA0 B12-0UFO	
Max. motor power (kW)		0.1	0.2	0.4	0.75	1	1.5	2	
Rated output current (A)		1.2	1.4	2.6	4.7	6.3	10.6	11.6	
Max. output current (A)		3.6	4.2	7.8	14.1	18.9	31.8	34.8	
Line supply	Voltage	1/3AC 200 V ... 240 V (–15% / +10%)				3AC 200 V ... 240 V (–15% / +10%)			
	Frequency	50 Hz / 60 Hz, (–10% / +10%)							
	Capacity (kVA) (1AC)	0.5	0.7	1.2	2	–	–	–	
	Capacity (kVA) (3AC)	0.5	0.7	1.1	1.9	2.7	4.2	4.6	
Cooling		Natural cooling				Fan cooling			
Frame size		FSA*		FSB		FSC			
Dimensions WxHxD (mm)		45x170x170*		55x170x170		80x170x195		95x170x195	
Weight approx. (kg)		1.07		1.20		1.94		2.49	
Line supply		380 ... 480 V 3AC							
Article No.	Pulse train: 6SL3210-5F PROFINET****: 6SL3210-5F	E10-4UA0 E10-4UFO	E10-8UA0 E10-8UFO	E11-0UA0 E11-0UFO	E111-5UA0 E111-5UFO	E12-0UA0 E12-0UFO	E13-5UA0 E13-5UFO	E15-0UA0 E15-0UFO	E17-0UA0 E17-0UFO
Max. motor power (kW)		0.4	0.75	1	1.75	2.5	3.5	5	7
Rated output current (A)		1.2	2.1	3	5.3	7.8	11	12.6	13.2
Max. output current (A)		3.6	6.3	9	15.9	23.4	33	37.8	39.6
Line supply	Voltage	3AC 380 V ... 480 V (–15% / +10%)							
	Frequency	50 Hz / 60 Hz, (–10% / +10%)							
	Capacity (kVA)	1.7	3	4.3	6.6	11.1	15.7	18	18.9
Cooling		Natural cooling				Fan cooling			
Frame size		FSAA		FSA		FSB		FSC	
Dimensions WxHxD (mm)		60x180x20		80x180x200		100x180x220		140x260x240	
Weight approx. (kg)		1.45		2.09		2.73		5.95	
Control power supply	Voltage**	24 V DC (–15% / +20%)							
	Current***	1.6 A (without holding brake) 3.6 A (with holding brake)							
Line supply system		TN, TT, IT, TT earthed line							
Overload capacity		300% x rated current for 300 ms every 10 s							
Control system		Servo control							
Braking resistor		Integrated							
Ambient temperature	Operation	0 °C to 45 °C: without power derating, 45 °C to 55 °C : with power derating							
	Storage	–40 °C to +70 °C							
Ambient humidity	Operation	<90% (no condensation)							
	Storage	90% (no condensation)							
Pollution class		2							
Vibration	Operation	Shock	Operational area II Peak acceleration: 5 g, 30 ms, 15 g, 11 ms Quantity of shocks: 3 per direction x 6 direction Duration of shock: 1 s						
		Vibration	Operational area II 10 Hz to 58 Hz: 0.075 mm deflection 58 Hz to 200 Hz: 1 g vibration						
	Product packaging	Vibration	2 Hz to 9 Hz: 3.5 mm deflection 9 Hz to 200 Hz: 1 g vibration Quantity of cycles: 10 per axis Sweep seed: 1 octave/min						
Degree of protection		IP20							
Altitude		≤1000 m (without power derating); >1000 m and up to 5000 m (with power derating)							
Standards		CE, KC, EAC, cULus, C-tick							
Interface		SINAMICS V90 Pulse train version (PTI)				SINAMICS V90 PROFINET version (PN)			
USB		Mini USB				Mini USB			
Pulse train input		2 channels, one exclusively for 5 V differential signal, one for 24 V single-end signal				–			
Pulse train encoder output		5 V differential signal, A, B, Z phase				–			
Digital inputs/outputs		10 inputs, NPN/PNP; 6 outputs, NPN				4 inputs, NPN/PNP; 2 outputs, NPN/PNP			
Analog outputs		2 analog outputs, output voltage range ±10 V, 10 bits				–			
Communication		USS/Modbus RTU (RS 485)				PROFINET RT/IRT interface with 2 ports (RJ45 sockets)			
SD card slot		Standard SD card with 400 V version, Micro SD card with 200 V version				Standard SD card with 400 V version, Micro SD card with 200 V version			
Safety functions		Safe Torque Off (STO) via terminal, SIL 2				Safe Torque Off (STO) via terminal, SIL 2			

Control features – SINAMICS V90 servo drive

Control modes		SINAMICS V90 Pulse train version (PTI)	SINAMICS V90 PROFINET (PN)
Control modes		<ul style="list-style-type: none"> Pulse train input position control (PTI) Internal position control (IPos), setpoints selected using a combination of digital inputs, or Modbus/USS Speed control (S) Torque control (T) Compound controls, switches between position control, speed control, and torque control Jog using buttons on the integrated operator panel 	<ul style="list-style-type: none"> Speed control mode: position and speed control in combination with a motion function (TO axis) of SIMATIC S7-1500/S7-1200 and PROFINET
Speed control	Speed input	External analog input or internal speed setpoint	PROFINET or internal speed setpoint
	Torque limit	External analog input or set using a parameter	PROFINET or set using a parameter
Pulse train input position control	Max. pulse frequency	<ul style="list-style-type: none"> Differential line driver (5 V), 1 MHz Optical coupler (24 V), 200 kHz 	–
	Multiplying factor	Electronic gear ratio (A/B), A:1-65535, B:1-65535, 1/50<A/B<200	–
	Torque limit	External analog input or set using a parameter	–
Torque control mode	Torque input	External analog input or internal torque setpoint	–
	Speed limit	Prevents speed limits from being violated, set using a parameter for analog input	Set using a parameter
Control features			
Real time auto tuning		Estimates the machine characteristic and sets the closed-loop control parameters (gain, integral time, etc.) continuously in real time without any user intervention	
Resonance suppression		Suppresses mechanical resonance, such as workpiece and foundation vibration	
One-button auto tuning		Estimates the machine load inertia and mechanical characteristics with internal movement command (pre-configured in the SINAMICS V90). This feature can be initiated using the SINAMICS V-ASSISTANT engineering tool	
Gain switch and PI/P switch		Switches between gains or from PI to P control using an external signal or internal operating conditions	–
Torque limit		Limits motor speed using an external analog input or internal torque limit	Motor torque is internally limited
Travel to fixed stop		–	Can be used to move an axis to a fixed stop at a specified torque without a signal fault
DI/DO parameterization		Freely assigns the control signals to digital inputs and digital outputs	
External braking resistor		An external braking resistor can be used when the internal braking resistor is not capable of handling the regenerative energy	
Measure machine		The machine frequency characteristics are analyzed using SINAMICS V-ASSISTANT	
Parameter cloning and Firmware update		Standard SD card with 400 V version, Micro SD card with 200 V version. Maximum supported capacity is 32 GB	
Safety functions		Safe torque off (STO) via terminal, complies with safety standard SIL 2 according to EN 61508 resp. PL d, Cat 3 according to EN ISO 13849 (activation only via terminals of SINAMICS V90, not supported via PROFINET/PROFIsafe)	
Basic Operator Panel (BOP)		Integrated, 6-digit / 7-segment display, 5 buttons	
Engineering PC tool		SINAMICS V-ASSISTANT engineering tool exclusively for SINAMICS V90. SINAMICS V90 in combination with S7-1500 and STEP 7 Professional engineering via TIA Portal V14 possible.	

- * SINAMICS V90 PROFINET 200 V version not available in frame size A (FSA).
The power range from 0.1 kW to 0.4 kW is covered with frame size B (FSB).
- ** When SINAMICS V90 controls a motor equipped with brake, the tolerance of the 24 V DC power supply must be –10% to +10% to comply with the voltage required by the brake.
- *** PROFINET version requires a 24 V DC supply with max. 1.5 A (without a holding brake), or 3.5 A (with a holding brake). Refer to the operating instructions for detailed information.
- **** SINAMICS V90 PROFINET 400 V version is available in the 2nd half of 2016

Connection diagram

Standard wiring for pulse train input (PTI) position control mode (for detailed information and connection diagrams for other control modes such as via PROFINET communication, please refer to the operating instructions). The diagram below provides a reference for selecting the drive type. When commissioning the selected servo drive system, establish the wiring connections according to the connection diagram and the instructions provided in the operating instructions.

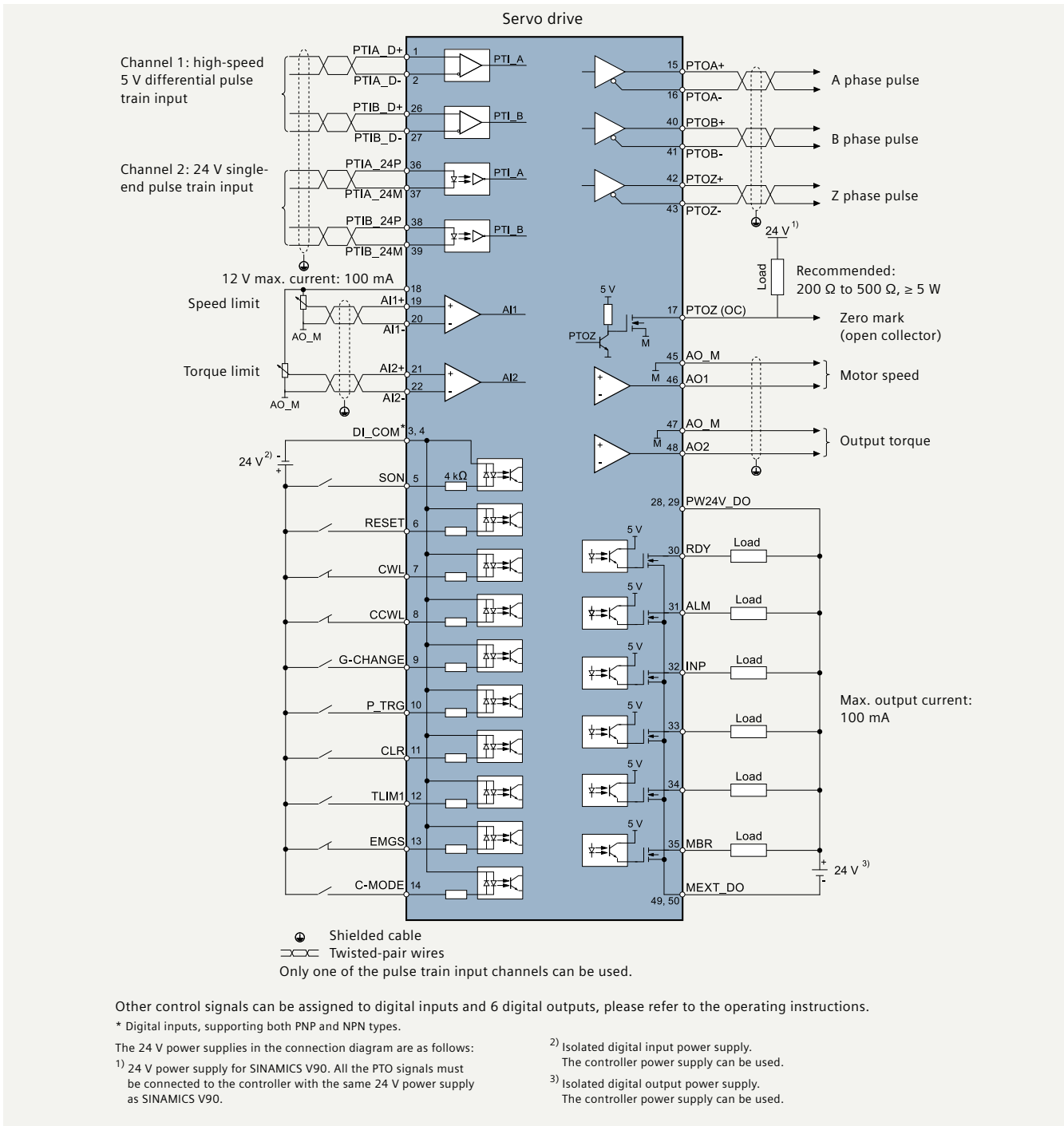

System at glance

SINAMICS V90 servo drive system
 1/3AC 200 ... 240 V Low Inertia (LI) for high dynamic performance

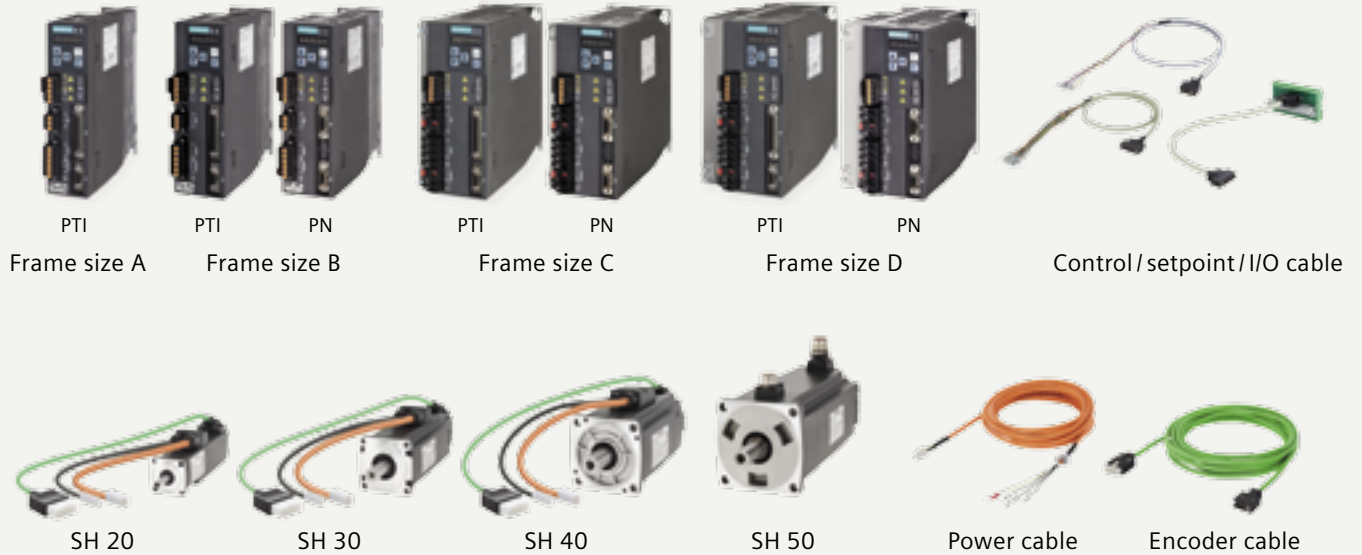

SINAMICS V90 servo drive system
 3AC 380 ... 480 V High Inertia (HI) for smooth operational performance

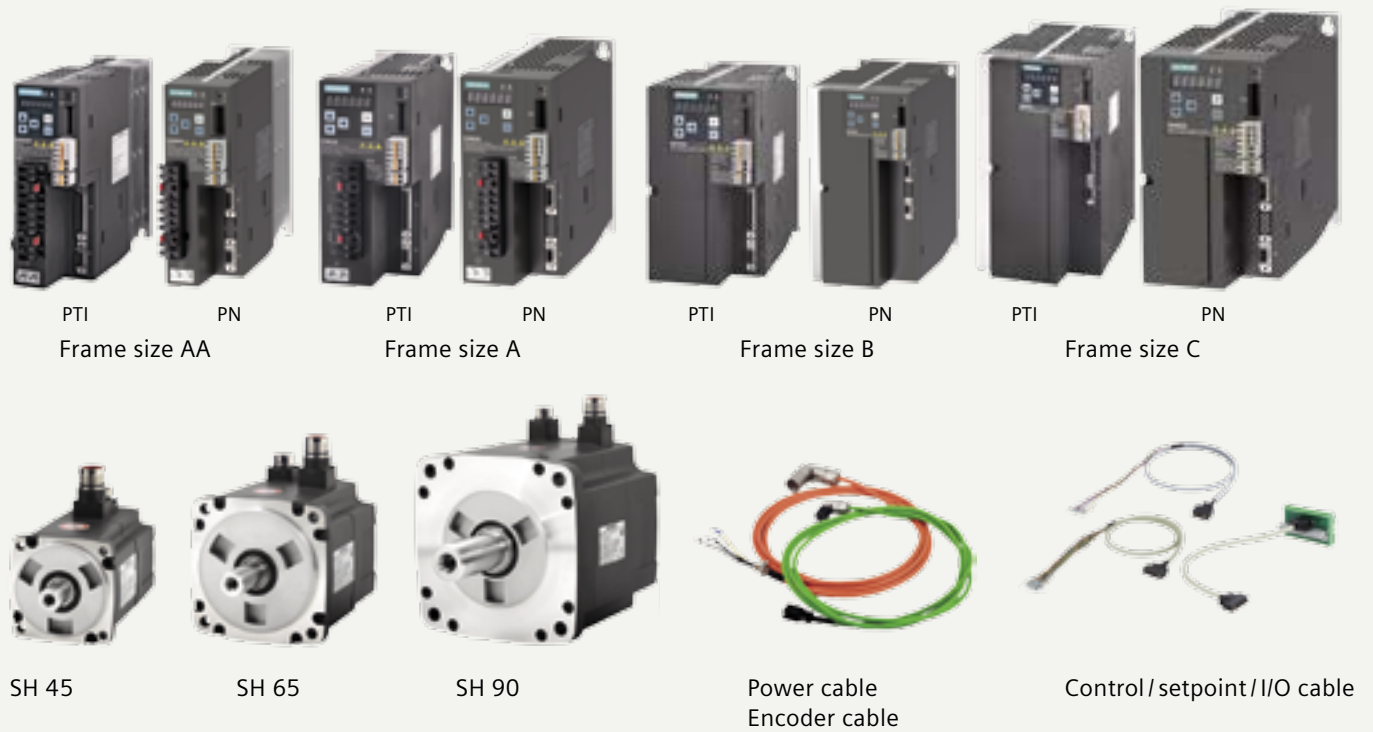

SINAMICS V90 servo drive

Pulse train version (PTI)

- RS 485 interface for MODBUS RTU/US5 to communicate with a PLC

SINAMICS PROFINET version

- 2 RJ45 connectors for PROFINET communication with a PLC

Status indicator

- RDY indicates servo ready/alarm state
- COM indicates communication with PC

Integrated operator panel

- 6 digits, 7-segment LED
- 5 buttons

High-quality connectors

Braking resistor

- If the internal braking resistor is not sufficient, disconnect DCP and R2, then connect DCP and R1 with an external braking resistor

Shield plate

- Easy shield connection to cables and improved EMC behavior

Standard mini USB socket

- To connect a PC with engineering tool

SD card slot

- To copy parameters
- Standard SD card slot (400 V version)
- Micro SD card slot (200 V version)

Safe Torque Off

Motor holding brake

(only for SINAMICS V90, 400 V version)

Control/status interface

Pulse train version Setpoint interface

- 50 pins
- Pulse train input
- Encoder emulation pulse output
- DI/DO, AI/AO
- Motor holding brake* (only for SINAMICS V90, 200 V version)

PROFINET version I/O interface

- 20 pins
- DI/DO
- Motor holding brake* (only for SINAMICS V90, 200 V version)

Motor encoder connector

* Motor holding brake signal (only for SINAMICS 200 V version). The SINAMICS V90, 200 V version requires an external relay to connect the motor holding brake.

SIMOTICS S-1FL6, High Inertia motor

- High-quality metal connector
- Quick-release connector
- IP65 as standard for all motors
- High-quality bearings
- Shaft sleeve protection
- Oil seal with high wear resistance

SIMOTICS S-1FL6, Low Inertia motor

- Cost-efficient, compact cable
- IP65 as standard for all motors
- High-quality bearings
- Oil seal with high wear resistance

System connection diagram

System connection diagram for the SINAMICS V90 pulse train version

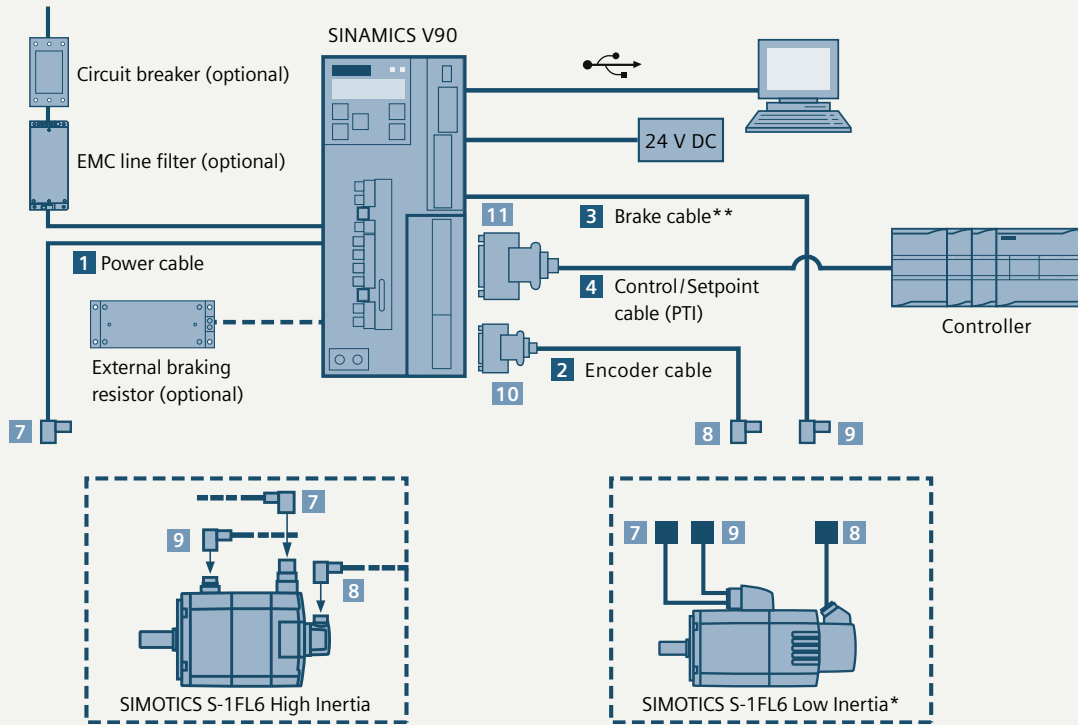

System connection diagram of SINAMICS V90 PROFINET version

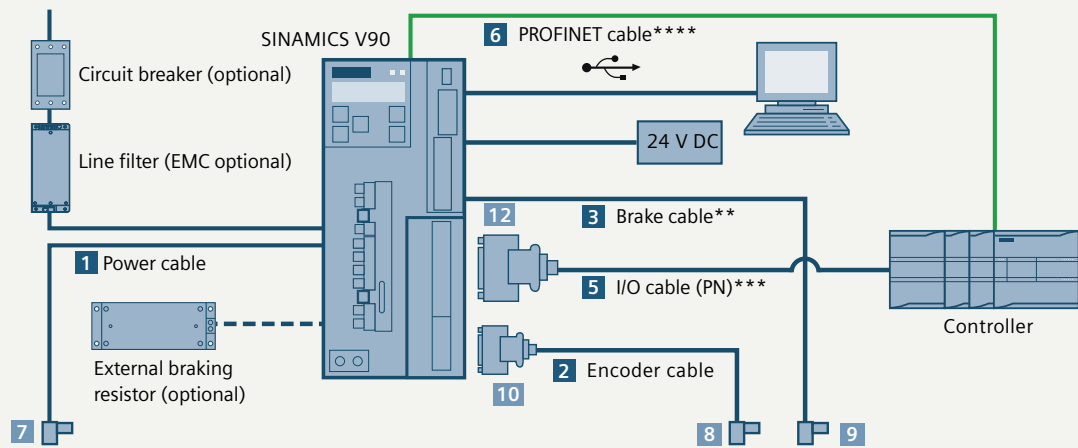

1	Power cable	7	Power connector (motor side)
2	Encoder cable	8	Encoder connector (motor side)
3	Brake cable	9	Brake connector (motor side)
4	Control/Setpoint cable (pulse train version)	10	Encoder connector (drive side)
5	I/O cable (PROFINET version)	11	Setpoint connector (Pulse train version)
6	PROFINET cable	12	I/O connector (PROFINET version)

* SIMOTICS S-1FL6 Low Inertia motors SH20, SH30, SH40 use outlet connection concept.

** Brake cable connection shown here is for 400 V version only. The 200 V version requires an external relay to connect the motor brake cable. The relay has to be connected via the setpoint cable for the SINAMICS V90 pulse train version and via I/O cable for the SINAMICS V90 PROFINET version.

*** I/O cable is necessary for the brake control of the SINAMICS V90 PROFINET 200 V version, and for applications requiring additional DI/DO in addition to PROFINET communication.

**** For further information of PROFINET cable refer to http://automation.siemens.com/sc-static/catalogs/catalog/IK_PI_2015_en.pdf

SIMOTICS S-1FL6 Low Inertia for high dynamic performance

Motor

Technical data								
Article number 1FL6	022-2AF	024-2AF	032-2AF	034-2AF	042-2AF	044-2AF	052-2AF	054-2AF
Shaft height (SH)	20		30		40		50	
Rated power (kW) ¹⁾	0.05	0.10	0.20	0.40	0.75	1.00	1.50	2.00
Horsepower (HP)	0.07	0.14	0.27	0.54	1.02	1.36	2.04	2.72
Rated torque (Nm)	0.16	0.32	0.64	1.27	2.39	3.18	4.78	6.37
Rated speed (rpm)	3000							
Maximum torque (Nm)	0.48	0.96	1.91	3.82	7.2	9.54	14.3	19.1
Maximum speed (r/min)	5000							
Rated current (A)	1.2	1.2	1.4	2.6	4.7	6.3	10.6	11.6
Maximum current (A)	3.6	3.6	4.2	7.8	14.2	18.9	31.8	34.8
Torque constant (Nm/A)	0.14	0.29	0.48	0.49	0.51	0.51	0.46	0.55
Moment of inertia (10 ⁻⁴ kg·m ²) (with brake)	0.031 (0.038)	0.052 (0.059)	0.214 (0.245)	0.351 (0.381)	0.897 (1.06)	1.15 (1.31)	2.04 (2.24)	2.62 (2.82)
Thermal class	B (130 °C)							
Degree of protection	IP65							
Recommended load to motor inertia ratio	Max. 30x				Max. 20x		Max. 15x	
Encoder types	Incremental encoder TTL 2500 ppr; Absolute encoder single-turn 21-bit (available in the 2nd half of 2016)							
Type of construction	IM B5 (IM V1 and IM V3)							
Weight (kg) (with brake)	0.47 (0.70)	0.63 (0.86)	1.02 (1.48)	1.46 (1.92)	2.8 (3.68)	3.39 (4.20)	5.35 (6.76)	6.56 (8.00)
Operating temperature	0 ~ 40 °C (without any restrictions)						0 ~ 30 °C (without any restrictions)	
Operating humidity	90% RH maximum (no condensation at 30 °C)							
Vibration severity grade	Grade A							
Radial runout tolerance	Class N							
Installation altitude	≤ 1000 m (without power derating); > 1000 m and up to 5000 m (with power derating)							
Standards								
Holding brake data ²⁾								
Holding torque (Nm)	0.32 Nm		1.27 Nm		3.18 Nm		6.37 Nm	
Rated voltage (V)	24 V DC ± 10%							
Opening time (ms)	35		75		105		90	
Closing time (ms)	10		10		15		35	
Rated current (A)	0.25		0.3		0.35		0.57	

¹⁾ Rated torque, rated power and maximum torque listed in the table above allow a production tolerance of 10%.

²⁾ It is not permissible to use the holding brake for an emergency stop.

SIMOTICS S-1FL6 Low Inertia

Torque-speed characteristic when connected to SINAMICS V90

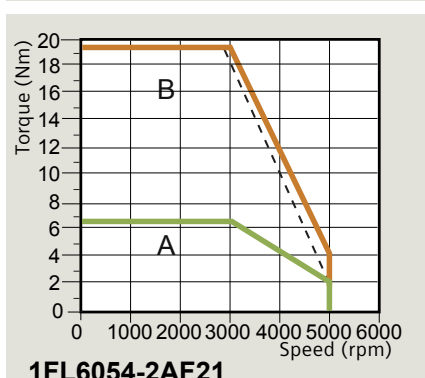
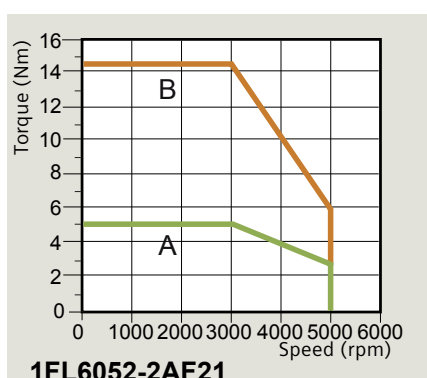
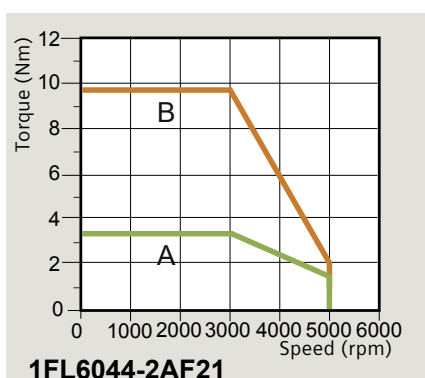
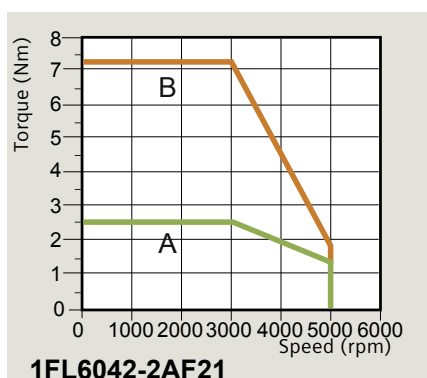
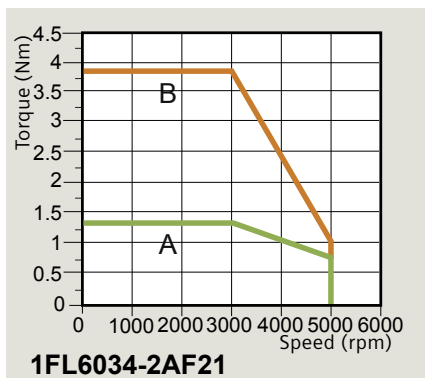
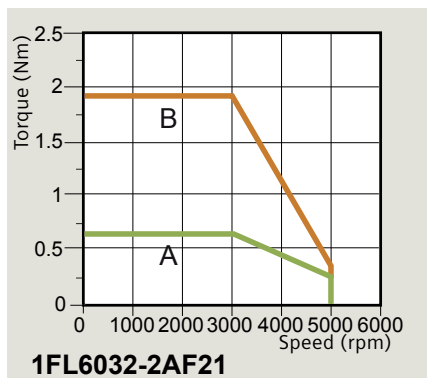
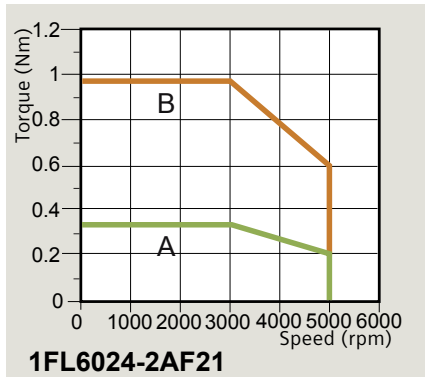
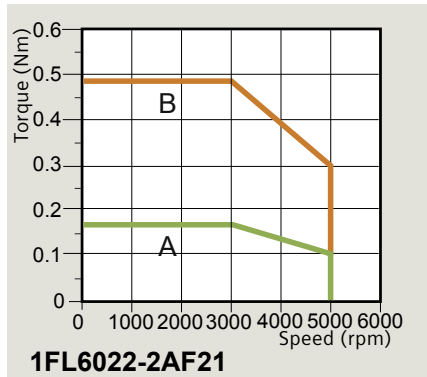

Notes:

- A: Continuous operating area
- B: Short-term operating area

- Supply voltage 220 V
- - - Supply voltage 198 V

SIMOTICS S-1FL6 High Inertia

Torque-speed characteristic when connected to SINAMICS V90

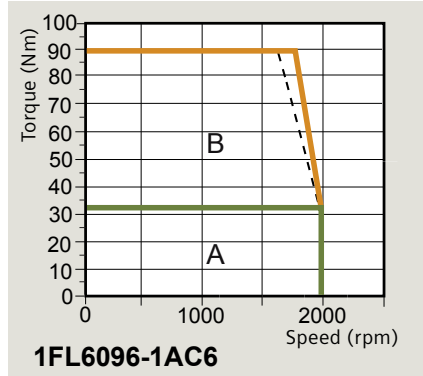
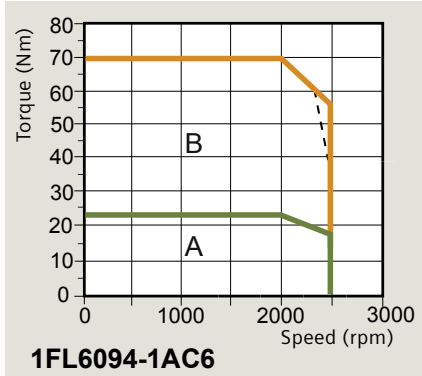
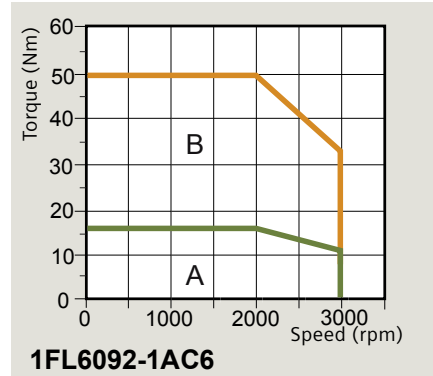
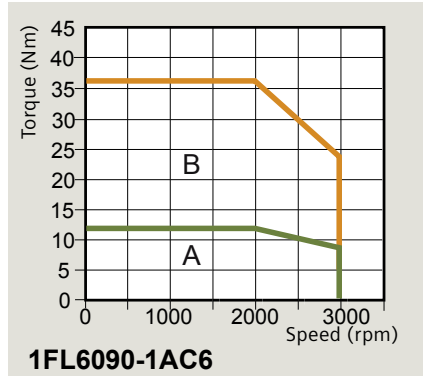
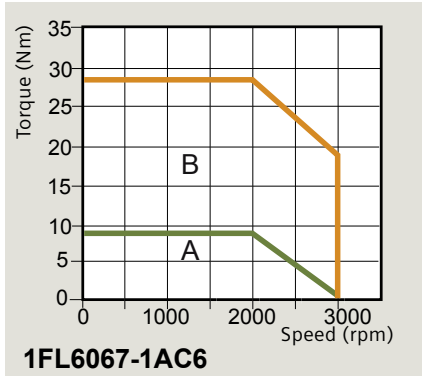
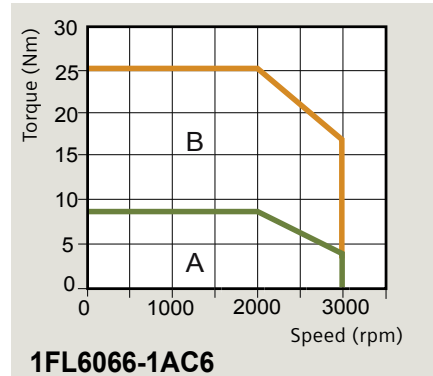
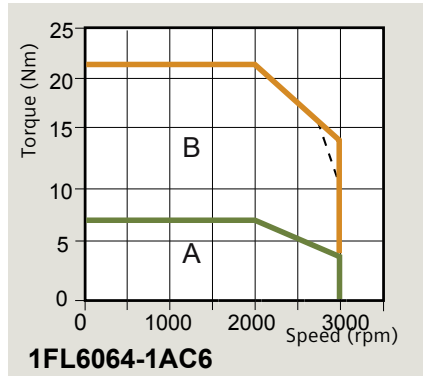
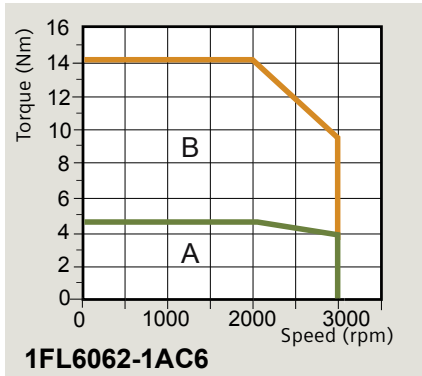
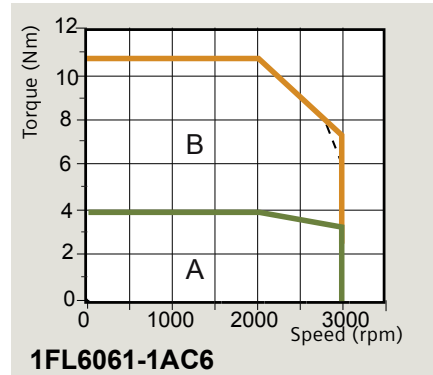
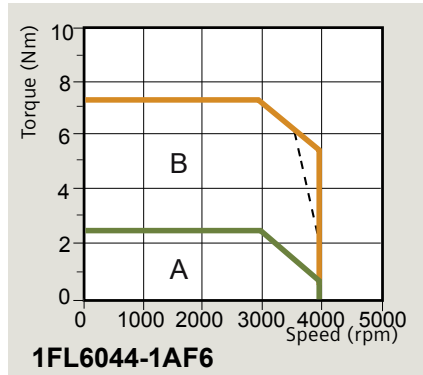
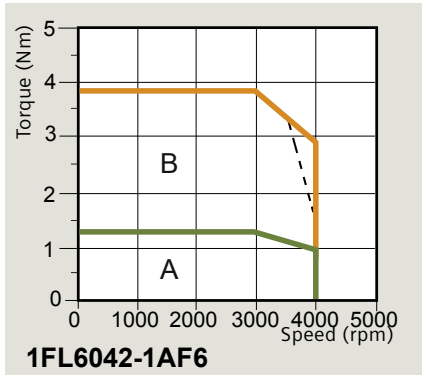

Notes:

- A: Continuous operating area
- B: Short-term operating area

- Supply voltage 400 V
- - - Supply voltage 380 V

SIMOTICS S-1FL6 High Inertia for smooth operation

Motor

Technical data											
Article number 1FL6	042- 1AF	044- 1AF	061- 1AC	062- 1AC	064- 1AC	066- 1AC	067- 1AC	090- 1AC	092- 1AC	094- 1AC	096- 1AC ²⁾
Shaft height (SH)	45		65					90			
Rated power (kW) ¹⁾	0.40	0.75	0.75	1.00	1.50	1.75	2.00	2.50	3.50	5.00	7.00
Horsepower (HP)	0.54	1.02	1.02	1.36	2.04	2.38	2.72	3.40	4.76	6.80	9.52
Rated torque (Nm) ¹⁾	1.27	2.39	3.58	4.78	7.16	8.36	9.55	11.90	16.70	23.90	33.40
Rated speed (rpm)	3000		2000					2000			
Maximum torque (Nm) ¹⁾	3.8	7.2	10.7	14.3	21.5	25.1	28.7	35.7	50.0	70.0	90.0
Maximum speed (rpm)	4000		3000					3000		2500	2000
Rated current (A)	1.2	2.1	2.5	3.0	4.6	5.3	5.9	7.8	11.0	12.6	13.2
Maximum current (A)	3.6	6.3	7.5	9.0	13.8	15.9	17.7	23.4	32.9	36.9	35.6
Torque constant (Nm/A)	1.1	1.2	1.5	1.7	1.6	1.7	1.7	1.6	1.6	2.0	2.7
Moment of inertia (10 ⁻⁴ kg·m ²) (with brake)	2.7 (3.2)	5.2 (5.7)	8.0 (9.1)	15.3 (16.4)	15.3 (16.4)	22.6 (23.7)	29.9 (31.0)	47.4 (56.3)	69.1 (77.9)	90.8 (99.7)	134.3 (143.2)
Thermal class	B (130 °C)										
Degree of protection	IP65										
Recommended load to motor inertia ratio	Max. 10x		Max. 5x					Max. 5x			
Encoder types	Incremental encoder TTL 2500 ppr Absolute encoder 20-bit + 12-bit multi-turn										
Type of construction	IM B5 (IM V1 and IM V3)										
Weight (kg) ⁴⁾ (with brake)	3.3 (4.6)	5.1 (6.4)	5.6 (8.6)	8.3 (11.3)	8.3 (11.3)	11.0 (14.0)	13.6 (16.6)	15.3 (21.3)	19.7 (25.7)	24.3 (30.3)	33.2 (39.1)
Operating temperature	0 ~ 40 °C (without any restrictions)										
Operating humidity	90% RH maximum (no condensation at 30 °C)										
Vibration severity grade	Grade A										
Radial runout tolerance	N										
Installation altitude	≤ 1000 m (without power derating); > 1000 m and up to 5000 m (with power derating)										
Standards											
Holding brake data ³⁾											
Holding torque (Nm)	3.5		12.0					30.0			
Rated voltage (V)	24 V DC ± 10%										
Opening time (ms)	60		180					220			
Closing time (ms)	45		60					115			
Rated current (A)	0.9		1.5					1.9			

¹⁾ The rated torque, rated power and maximum torque listed in the table above allow for a production tolerance of 10%.

²⁾ For SIMOTICS S-1FL6 motors with brake, when the ambient temperature exceeds 30 °C, the power should be derated by 10%. Power derating is not required for other motors.

³⁾ It is not permissible to use the holding brake for an emergency stop.

⁴⁾ Motor weight with incremental encoder.

There's more to it:
siemens.com/ids

**Discover in detail how
Integrated Drive Systems boost
your competitive edge and
improve your time to profit.**

Integrated
Drive Systems
to go: Visit our
mobile site!



Follow us on:
www.twitter.com/siemensindustry
www.youtube.com/siemens

**Published by
Siemens AG 2016**

Digital Factory
P.O. Box 31 80
91050 Erlangen, Germany

Article No. E20001-A280-P670-V3-7600
Printed in Germany
Dispo 21500
WÜ/79794 WS 04168.0

Subject to changes and errors.
The information given in this document only contains general descriptions and/or performance features which may not always specifically reflect those described, or which may undergo modification in the course of further development of the products. The requested performance features are binding only when they are expressly agreed upon in the concluded contract.

For the secure operation of Siemens products and solutions, it is necessary to take suitable preventive action (e.g. cell protection concept) and integrate each component into a holistic, state-of-the-art industrial security concept. Third-party products that may be in use should also be considered. For more information about industrial security, visit <http://www.siemens.com/industrialsecurity>

SIEMENS
Ingenuity for life



SINAMICS V90

Step-by-step selection
and ordering information

[siemens.com/sinamics-v90](https://www.siemens.com/sinamics-v90)

SINAMICS V90 servo drive system

Step-by-step selection

1 Select your motor: SIMOTICS S-1FL6

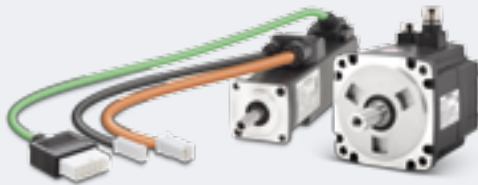

1. Select your motor based on the control properties:

- **Low Inertia** motor for the highest dynamic performance in terms of speed and acceleration
- **High Inertia** motor for better load adaptation and optimum control quality in terms of torque and speed accuracy

2. Determine the motor power rating at the required torque and speed

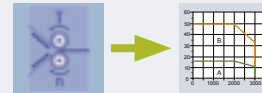

3. Select encoder resolution
4. Select motor holding brake
5. Determine shaft type

2 Select your servo drive: SINAMICS V90



1. Select your servo drive based on the motor power rating and communication

SIMOTICS S-1FL6		
	Power (kW)	Article number
High perf. (Low Inertia)	0.05	1FL6022-2AF21-1□□1

Smooth operation (High Inertia)	2.00	1FL6054-2AF21-0□□1
	0.40	1FL6042-1AF61-0□□1
...
7.00	1FL6096-1AC61-0□□1	

SINAMICS V90		
Power (kW)	Line supply voltage	Article number
0.05	230 V 1AC/3AC	6SL3210-5FB10-1UC□□
...
2.00	230 V 3AC	6SL3210-5FB12-0UC□□
0.40	400 V 3AC	6SL3210-5FE10-4UC□□
...
7.00	400 V 3AC	6SL3210-5FE17-0UC□□

3 Select your cables



1. Select your MOTION-CONNECT 300 connection system

- Power cable acc. to length and cross section
- Encoder cable acc. to length and encoder type
- Brake cable when motor holding brake is selected acc. to length

2. Control/setpoint cable to connect the drive to the PLC

4 Select your controller



1. Select your SIMATIC S7 controller

- Basic Controller SIMATIC S7-1200 or
- Advanced Controller SIMATIC S7-1500/1500 T-CPU



The optimum servo drive solution
SINAMICS V90
has now been configured!

SINAMICS V90 servo drive system

Step-by-step selection

Ordering information:

1 SIMOTICS S-1FL6 servomotor						2 SINAMICS V90 servo drive				
	Rated Power (kW)	Rated torque (Nm)	Rated speed (rpm)	Shaft height (mm)	Article number	Rated power (kW)	Line supply voltage	Frame size	Article number	
High dynamic performance (Low Inertia)	0.05	0.16	3000	20	1FL6022-2AF21-1	0.10	200 ... 240 V 1AC / 3AC	FSA***	6SL3210-5FB10-1U	
	0.10	0.32	3000		1FL6024-2AF21-1	0.20			6SL3210-5FB10-2U	
	0.20	0.64	3000	30	1FL6032-2AF21-1	0.40			FSB	6SL3210-5FB10-4U
	0.40	1.27	3000		1FL6034-2AF21-1	0.75			FSC	6SL3210-5FB10-8U
	0.75	2.39	3000	40	1FL6042-2AF21-1	1.00	200 ... 240 V 3AC	FSD	6SL3210-5FB11-0U	
	1.00	3.18	3000		1FL6044-2AF21-1	1.50			6SL3210-5FB11-5U	
	1.50	4.78	3000	50	1FL6052-2AF21-0	2.00			6SL3210-5FB12-0U	
	2.00	6.37	3000		1FL6054-2AF21-0					
Encoder type					Incremental encoder TTL 2500 ppr			A		
					Absolute encoder single-turn 21-bit*			M		
Smooth operation (High Inertia)	0.40	1.27	3000	45	1FL6042-1AF61-0	0.40	380 ... 480 V 3AC	FSAA	6SL3210-5FE10-4U	
	0.75	2.39	3000		1FL6044-1AF61-0	0.75			FSA	6SL3210-5FE10-8U
	0.75	3.58	2000	65	1FL6061-1AC61-0	0.75				6SL3210-5FE11-0U
	1.00	4.77	2000		1FL6062-1AC61-0	1.00			FSB	6SL3210-5FE11-5U
	1.50	7.16	2000		1FL6064-1AC61-0	1.50	6SL3210-5FE12-0U			
	1.75	8.4	2000		1FL6066-1AC61-0	2.00				
	2.00	9.5	2000		1FL6067-1AC61-0	2.50	FSC	6SL3210-5FE13-5U		
	2.50	11.9	2000	90	1FL6090-1AC61-0	3.50		6SL3210-5FE15-0U		
	3.50	16.7	2000		1FL6092-1AC61-0	5.00		6SL3210-5FE17-0U		
	5.00	23.9	2000		1FL6094-1AC61-0	7.00				
7.00	33.4	2000		1FL6096-1AC61-0						
Encoder type					Incremental encoder TTL 2500 ppr			A		
					Absolute encoder 20-bit + 12-bit multi-turn			L		
Shaft type					Feather key, without holding brake			A		
feather key and holding brake					Feather key, with holding brake**			B		
					Plain shaft, without holding brake			G		
					Plain shaft, with holding brake**			H		

* available in the 2nd half of 2016

** The SIMOTICS S-1FL6 Low Inertia motor requires an external relays to actuate the motor holding brake. See SINAMICS V90 operating instructions.

SINAMICS V90 pulse train (PTI) version
SINAMICS V90 PROFINET (PN) version
(V90 PROFINET version 400 V available in the 2nd half of 2016)

*** SINAMICS V90 PROFINET 200 V version is not available in frame size A (FSA). The power range from 0.1 kW to 0.4 kW is covered with frame size B (FSB).

Recommended line-side components											
SINAMICS V90		Recommended line filter ¹⁾		Recommended fuse/circuit breaker – IEC-compliant				Recommended fuse/circuit breaker to – UL-compliant			
Line supply voltage	Article number	Rated current	Article number	Fuse	Circuit breaker	Fuse	Circuit breaker	Fuse	Circuit breaker	Fuse	Article number
200 ... 240 V 1AC	B10-1	18 A	6SL3203-0BB21-8VA0	6 A	3NA3 801-2C	2.8–4 A, 230/240 V	3RV 2011-1EA10	6 A	Listed JDDZ	2.8–4 A, 230/240 V	3RV 2011-1EA10
	B10-2			6 A	3NA3 801-2C	2.8–4 A, 230/240 V	3RV 2011-1EA10	6 A	Listed JDDZ	2.8–4 A, 230/240 V	3RV 2011-1EA10
	B10-4			10 A	3NA3 803-2C	5.5–8 A, 230/240 V	3RV 2011-1HA10	10 A	Listed JDDZ	5.5–8 A, 230/240 V	3RV 2011-1HA10
	B10-8			16 A	3NA3 803-2C	9–12.5 A, 230/240 V	3RV 2011-1KA10	20 A	Listed JDDZ	9–12.5 A, 230/240 V	3RV 2011-1KA10
200 ... 240 V 3AC	B10-1	5 A	6SL3203-0BE15-0VA0	6 A	3NA3 801-2C	2.8–4 A, 230/240 V	3RV 2011-1EA10	6 A	Listed JDDZ	2.8–4 A, 230/240 V	3RV 2011-1EA10
	B10-2			6 A	3NA3 801-2C	2.8–4 A, 230/240 V	3RV 2011-1EA10	6 A	Listed JDDZ	2.8–4 A, 230/240 V	3RV 2011-1EA10
	B10-4			10 A	3NA3 803-2C	2.8–4 A, 230/240 V	3RV 2011-1EA10	10 A	Listed JDDZ	2.8–4 A, 230/240 V	3RV 2011-1EA10
	B10-8			16 A	3NA3 805-2C	5.5–8 A, 230/240 V	3RV 2011-1HA10	20 A	Listed JDDZ	5.5–8 A, 230/240 V	3RV 2011-1HA10
	B11-0	12 A	6SL3203-0BE21-2VA0	16 A	3NA3 805-2C	7–10 A, 230/240 V	3RV 2011-1JA10	20 A	Listed JDDZ	7–10 A, 230/240 V	3RV 2011-1JA10
	B11-5			25 A	3NA3 810-2C	10–16 A, 230/240 V	3RV 2011-4AA10	25 A	Listed JDDZ	10–16 A, 230/240 V	3RV 2011-4AA10
B12-0	25 A	3NA3 810-2C	10–16 A, 230/240 V	3RV 2011-4AA10	25 A	Listed JDDZ	10–16 A, 230/240 V	3RV 2011-4AA10			
380 ... 480 V 3AC	E10-4	5 A	6SL3203-0BE15-0VA0	6 A	3NA3801-6	3.2 A, 690 V AC	3RV 2021-1DA10	10 A	Listed JDDZ	3.2 A, 600 V AC	3RV 2021-1DA10
	E10-8			6 A	3NA3801-6	4 A, 690 V AC	3RV 2021-1EA10	10 A	Listed JDDZ	4 A, 690 V AC	3RV 2021-1EA10
	E11-0			10 A	3NA3803-6	5 A, 690 V AC	3RV 2021-1FA10	10 A	Listed JDDZ	5 A, 690 V AC	3RV 2021-1FA10
	E11-5			10 A	3NA3803-6	10 A, 690 V AC	3RV 2021-1HA10	15 A	Listed JDDZ	10 A, 690 V AC	3RV 2021-1HA10
	E12-0	12 A	6SL3203-0BE21-2VA0	16 A	3NA3805-6	16 A, 690 V AC	3RV 2021-4AA10	15 A	Listed JDDZ	16 A, 690 V AC	3RV 2021-4AA10
	E13-5			20 A	3NA3807-6	20 A, 690 V AC	3RV 2021-4BA10	25 A	Listed JDDZ	20 A, 690 V AC	3RV 2021-4BA10
	E15-0	20 A	6SL3203-0BE22-0VA0	20 A	3NA3807-6	20 A, 690 V AC	3RV 2021-4BA10	25 A	Listed JDDZ	20 A, 690 V AC	3RV 2021-4BA10
	E17-0			25 A	3NA3810-6	25 A, 690 V AC	3RV 2021-4DA10	25 A	Listed JDDZ	25 A, 690 V AC	3RV 2021-4DA10

3A ¹⁾ With one of the recommended line filters, EN 61008-3 category C2 can be reached in combination with SINAMICS V90, more information please refer to SINAMICS V90 Operating instruction – EMC instructions.

²⁾ When the internal braking resistor is not sufficient, select a standard braking resistor according to the table.

³⁾ 7 m cable length is only available for high inertia motors (3AC 400 V).

3 MOTION-CONNECT 300 cables between SINAMICS V90 servo drive and SIMOTICS S-1FL6 servomotor

Power cable	Encoder cable	Brake cable
Article number	Article number	Article number
6FX3002-5CK01-1 <input type="checkbox"/> <input type="checkbox"/> 0	6FX3002-2 <input type="checkbox"/> <input type="checkbox"/> 20-1 <input type="checkbox"/> <input type="checkbox"/> 0	6FX3002-5BK02-1 <input type="checkbox"/> <input type="checkbox"/> 0
6FX3002-5CK31-1 <input type="checkbox"/> <input type="checkbox"/> 0	6FX3002-2 <input type="checkbox"/> <input type="checkbox"/> 10-1 <input type="checkbox"/> <input type="checkbox"/> 0	6FX3002-5BL02-1 <input type="checkbox"/> <input type="checkbox"/> 0
6FX3002-5CL01-1 <input type="checkbox"/> <input type="checkbox"/> 0	6FX3002-2 <input type="checkbox"/> <input type="checkbox"/> 10-1 <input type="checkbox"/> <input type="checkbox"/> 0	6FX3002-5BL02-1 <input type="checkbox"/> <input type="checkbox"/> 0
6FX3002-5CL11-1 <input type="checkbox"/> <input type="checkbox"/> 0		
Length: 3 m	A D	A D
Length: 5 m	A F	A F
Length: 7 m ³⁾	A H	A H
Length: 10 m	B A	B A
Length: 20 m	C A	C A
For incremental encoder TTL 2500 ppr	C T	
For absolute encoder single-turn 21-bit	D B	
Absolute encoder 20-bit + 12-bit multi-turn		

Cables between SINAMICS V90 servo drive and PLC

Article number
6SL3260-4NA00-1VB0
Control/setpoint cable, 1 m cable with connector (MDR 50-pin connector, free pins to controller side)

or

6SL3260-4NA00-1VA5
Control/setpoint cable 0.5 m cable with connectors on both sides and separate terminal block (MDR 50-pin connector, terminal block to controller side)

I/O cable between SINAMICS V90 drive and controller

Article number
6SL3260-4MA00-1VB0
I/O cable, 1 m cable with 20-pin MDR connector (free pins to controller side)

PROFINET cable

6GK1901-1BB10-2AA0
RJ45 data plug-in connector, with 180° (straight) cable outlet

6XV1840-2AH10
Standard bus cable (4-core), sold by meter, not assembled

6XV1871-5BH10
Preassembled cable, 1 m, with two RJ45 plug-180

Requirements for external braking resistor

External braking resistor ²⁾					
Line supply voltage	Frame size	Resistance (Ω)	Max. power (kW)	Rated power (W)	Max. energy (kJ)
200 ... 240 V 1AC/3AC	FSA	150	1.09	20	0.8
	FSB	100	1.64	21	1.23
	FSC	50	3.28	62	2.46
	FSD, 1 kW	50	3.28	62	2.46
	FSD, 1.5 to 2 kW	25	6.56	123	4.92
380 ... 480 V 3AC	FSAA	533	1.2	30	2.4
	FSA	160	4	100	8
	FSB	70	9.1	229	18.3
	FSC	27	23.7	1185	189.6

Replacement parts

Replacement connector kits (contains control connectors, power connectors)	for SINAMICS V90 400 V FSAA	6SL3200-0WT00-0AA0
	for SINAMICS V90 400 V FSA	6SL3200-0WT01-0AA0
	for SINAMICS V90 200 V FSA/FSB	6SL3200-0WT02-0AA0
	for SINAMICS V90 200 V FSC/FSD	6SL3200-0WT03-0AA0
Replacement fan	for SINAMICS V90 400 V FSB, 200 V FSD	6SL3200-0WF00-0AA0
	for SINAMICS V90 400 V FSC	6SL3200-0WF01-0AA0

Connectors

Connectors	Plug on	Article number	Packaging unit (pcs)
50-pin MDR connector for setpoint cable	drive side	6SL3260-2NA00-0VA0	30
Encoder connector	drive side	6FX2003-0SB14	30
20-pin MDR connector for I/O cable	drive side	6SL3260-2MA00-0VA0	5
Power connector	motor side	6FX2003-0LL1 <input type="checkbox"/>	
Incremental encoder TTL 2500 ppr connector	motor side	6FX2003-0SL1 <input type="checkbox"/>	
Brake connector	motor side	6FX2003-0LL5 <input type="checkbox"/>	
Absolute encoder single-turn 21-bit Absolute encoder 20-bit + 12-bit multi-turn connector	motor side	6FX2003-0DB1 <input type="checkbox"/>	
For SIMOTICS S-1FL6 motors with shaft heights of 45, 50, 65, 90			1 30
For SIMOTICS S-1FL6 motors with shaft heights of 20, 30, and 40			2 5

SIMATIC S7 controller

4 SINAMICS V90 pulse train (PTI), USS/Modbus RTU version to SIMATIC controller

SIMATIC S7-1200 Basic controller			Communication	
CPU	Article number	Digital outputs	RS 485 communication for USS or Modbus RTU	Article number
CPU 1211C DC/DC/DC	6ES7211-1□□□□-0XB0	4 DO with 100 kHz rest 30 kHz	CM 1241 RS 422/485 or CB 1241 RS 485	6ES7241-1CH32-0XB0 or 6ES7241-1CH30-0XB0
CPU 1212C DC/DC/DC	6ES7212-1□□□□-0XB0			
CPU 1214C DC/DC/DC	6ES7214-1□□□□-0XB0			
CPU 1215C DC/DC/DC	6ES7215-1□□□□-0XB0			
CPU 1217C DC/DC/DC	6ES7217-1□□□□-0XB0	4 DO with 1 MHz rest 100 kHz		
Signal boards			Note: One SIMATIC S7-1200 CPU can control up to 4 SINAMICS V90 axes, while each axis requires 2 fast digital output for the pulse train interface. One SIMATIC S7-1200 CPU is only expandable with either a signal board or a communication board.	
CPU	Article number	Digital outputs	For detailed and further information about SIMATIC controllers please refer to the SIMATIC S7-1200 brochure, catalog or web page: http://siemens.com/simatic-s7-1200	
SB 1222 DC 200 kHz	6ES7222-1BD30-0XB0	4 x 24 V DC 200 kHz		
SB 1222 DC 200 kHz	6ES7222-1AD30-0XB0	4 x 5 V DC 200 kHz		
SB 1223 DC/DC 200 kHz	6ES7223-3BD30-0XB0	2 x 24 V DC 200 kHz		
SB 1223 DC/DC 200 kHz	6ES7223-3AD30-0XB0	2 x 5 V DC 200 kHz		

4 SINAMICS V90 PROFINET version to SIMATIC controller

SIMATIC S7-1500/1500 T for advanced motion control				SIMATIC S7-1200 for basic motion control	
Standard CPU	Article number	Failsafe CPU	Article number	CPU	Article number
S7-1511	6ES7511-1AK01-0AB0	S7-1511F	6ES7511-1FK01-0AB0	1211C DC/DC/DC	6ES7211-1□□□□-0XB0
S7-1513	6ES7513-1AL01-0AB0	S7-1513F	6ES7513-1FL01-0AB0	1212C DC/DC/DC	6ES7212-1□□□□-0XB0
S7-1515	6ES7515-2AM01-0AB0	S7-1515F	6ES7515-2FM01-0AB0	1214C DC/DC/DC	6ES7214-1□□□□-0XB0
S7-1516	6ES7516-3AN01-0AB0	S7-1516F	6ES7516-3FN01-0AB0	1215C DC/DC/DC	6ES7215-1□□□□-0XB0
S7-1517	6ES7517-3AP00-0AB0	S7-1517F	6ES7517-3FP00-0AB0	1217C DC/DC/DC	6ES7217-1□□□□-0XB0
S7-1518	6ES7518-4AP00-0AB0	S7-1518F	6ES7518-4FP00-0AB0		
Technology CPU	Article number	Failsafe CPU	Article number	For further information about PROFINET cables refer to http://automation.siemens.com/sc-static/catalogs/catalog/IK_PI_2015_en.pdf For further information about SIMATIC controllers please refer to the SIMATIC S7 catalog or web page: http://siemens.com/simatic	
S7-1511T	6ES7511-1TK01-0AB0	–	–		
S7-1515T	6ES7515-2TM01-0AB0	–	–		
S7-1517T	6ES7517-3TP00-0AB0	S7-1517TF	6ES7517-3UP00-0AB0		
Note: Technology Objects: SINAMICS V90 as a PROFINET I/O device with PROFIdrive supports technology objects of S7-1200/S7-1500/S7-1500 T-CPU for speed and positioning control. Function blocks: SINAMICS V90 only supports SINA_SPEED (speed), SINA_POS (positioning) is NOT supported yet.					

Accessories	
Training case SINAMICS V90 LI, 200 V (PTI, USS/Modbus RTU version)	6AG1067-2AA00-OACO
SINAMICS SD card for SINAMICS V90 in 400 V version	6SL3054-4AG00-2AA0

SINAMICS V90

Dimensions and mounting clearances

Dimension drawings (mm)

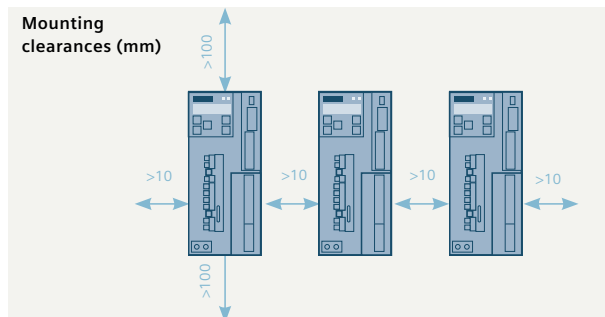
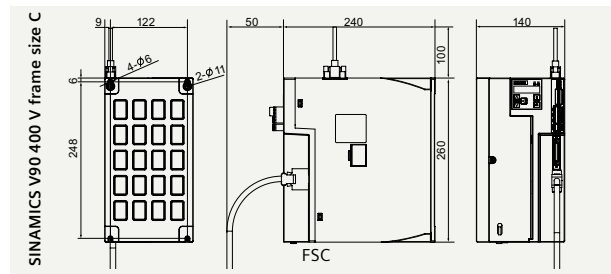
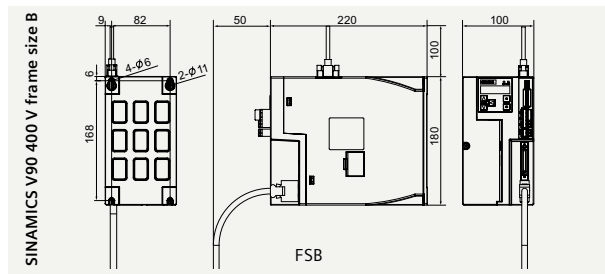
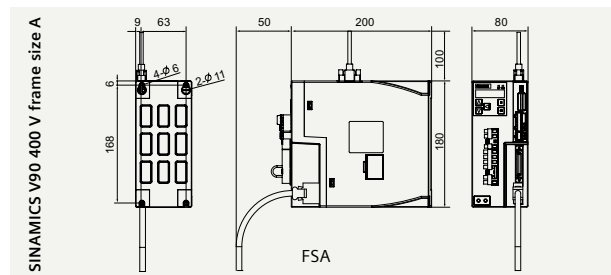
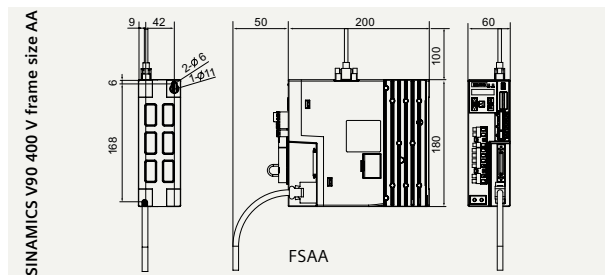
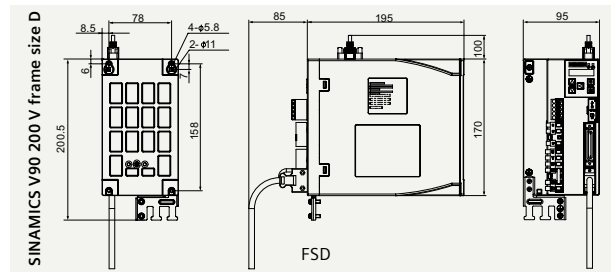
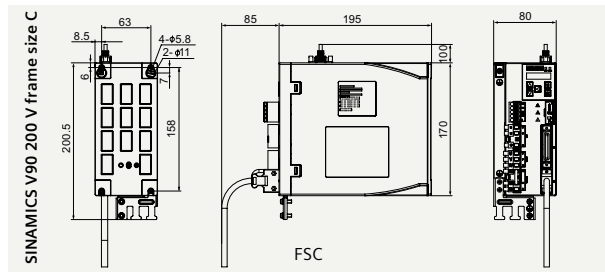
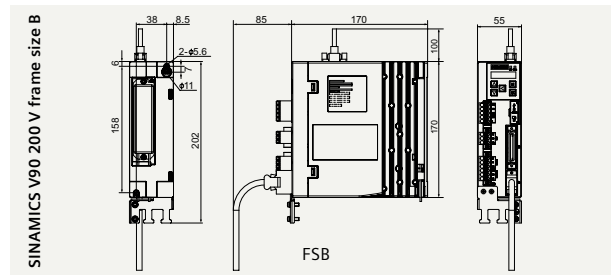
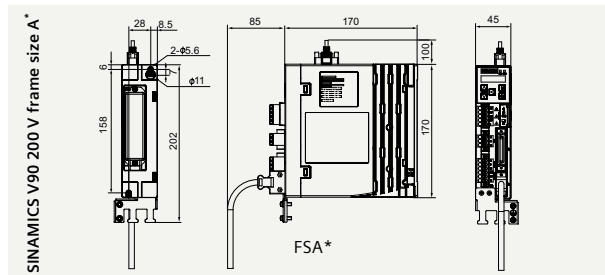

* SINAMICS V90 PROFINET 200 V version is not available in frame size A (FSA). The power range from 0.1 kW to 0.4 kW is covered with frame size B (FSB)

SIMOTICS S-1FL6 Low Inertia

Dimension drawings (mm) SIMOTICS S-1FL6 Low Inertia servomotors

Shaft height															Without brake		With brake					
	Type	LC	LA	LZ	LB	LH	LR	T	LG	D	DB	E	QK	GA	F	LL	KB1	LL	KB1	KB2	KL1	KL2
20	1FL6022-2AF	40	46	4.5	30	40	25	2.5	6	8	M3x8	22	17.5	9	3	86	-	119	-	-	-	-
	1FL6024-2AF	40	46	4.5	30	40	25	2.5	6	8	M3x8	22	17.5	9	3	106	-	139	-	-	-	-
30	1FL6032-2AF	60	70	5.5	50	50	31	3	8	14	M4x15	26	22.5	16	5	98	-	132.5	-	-	-	-
	1FL6034-2AF	60	70	5.5	50	50	31	3	8	14	M4x15	26	22.5	16	5	123	-	157.5	-	-	-	-
40	1FL6042-2AF	80	90	7	70	60	35	3	8	19	M6x16	30	28	21.5	6	139	-	178.3	-	-	-	-
	1FL6044-2AF	80	90	7	70	60	35	3	8	19	M6x16	30	28	21.5	6	158.8	-	198.1	-	-	-	-
50	1FL6052-2AF	100	115	9	95	-	45	3	12	19	M6x16	40	28	21.5	6	192	143.5	226	177.5	32.5	135	80
	1FL6054-2AF	100	115	9	95	-	45	3	12	19	M6x16	40	28	21.5	6	216	167.5	250	201.5	32.5	135	80

SH20, SH30 and SH40

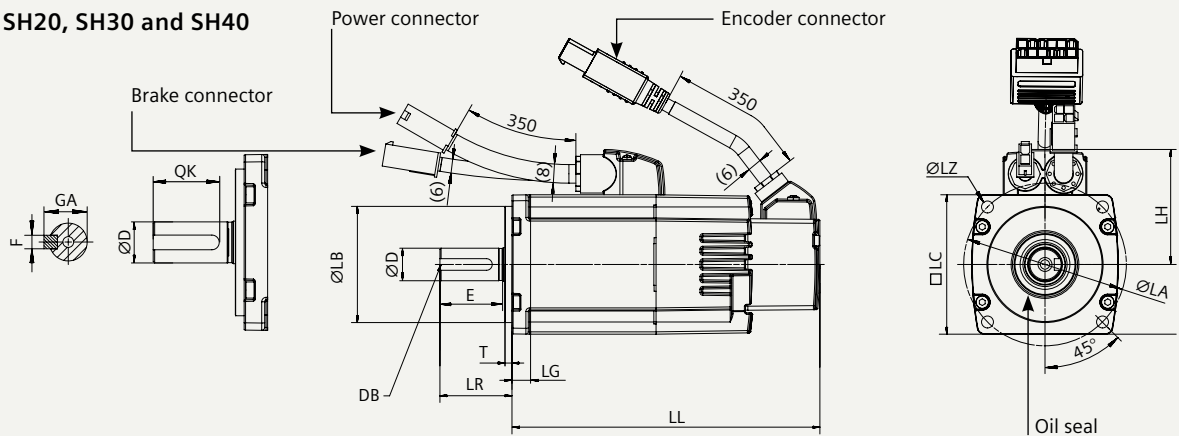

SH50

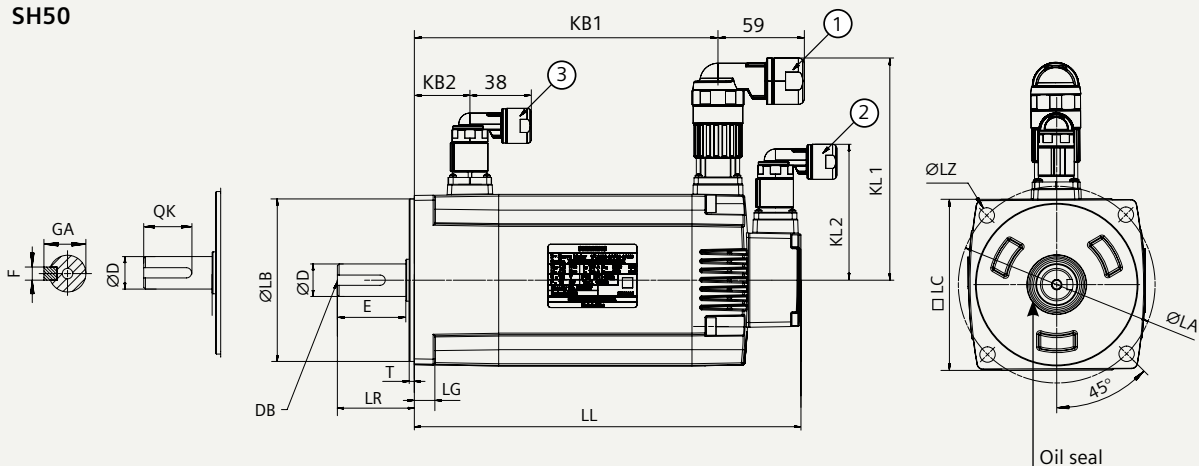

Note: ① Power connector, ② Incremental encoder connector, ③ Brake connector
 Connectors should be ordered separately, for ordering information please refer to section "Options" in this document.
 Outline dimensions of ② incremental encoder connector ③ brake connector are the same.

SIMOTICS S-1FL6 High Inertia

Dimension drawings (mm) SIMOTICS S-1FL6 High Inertia servomotors with incremental encoder

Shaft height	Type														Without brake			With brake						
		LC	LA	LZ	LB	LR	T	LG	D	DB	E	QK	GA	F	LL	KB1	KB2	LL	KB1	KB2	KL1	KL2	KL3	KL4
45	1FL6042-1AF	90	100	7	80	35	4	10	19	M6x16	30	25	21.5	6	154.5	93.5	-	201	140	31.5	136	92	-	-
	1FL6044-1AF	90	100	7	80	35	4	10	19	M6x16	30	25	21.5	6	201.5	140.5	-	248	187	31.5	136	92	-	-
65	1FL6061-1AC	130	145	9	110	58	6	12	22	M8x16	50	44	25	8	148	85.5	-	202.5	140	39.5	158	115	23	22
	1FL6062-1AC	130	145	9	110	58	6	12	22	M8x16	50	44	25	8	181	118.5	-	235.5	173	39.5	158	115	23	22
	1FL6064-1AC	130	145	9	110	58	6	12	22	M8x16	50	44	25	8	181	118.5	-	235.5	173	39.5	158	115	23	22
	1FL6066-1AC	130	145	9	110	58	6	12	22	M8x16	50	44	25	8	214	151.5	-	268.5	206	39.5	158	115	23	22
	1FL6067-1AC	130	145	9	110	58	6	12	22	M8x16	50	44	25	8	247	184.5	-	301.5	239	39.5	158	115	23	22
90	1FL6090-1AC	180	200	13.5	114.3	80	3	18	35	M12x25	75	60	38	10	189.5	140	-	255	206	44.5	184	149	34	34
	1FL6092-1AC	180	200	13.5	114.3	80	3	18	35	M12x25	75	60	38	10	211.5	162	-	281	232	44.5	184	149	34	34
	1FL6094-1AC	180	200	13.5	114.3	80	3	18	35	M12x25	75	60	38	10	237.5	188	-	307	258	44.5	184	149	34	34
	1FL6096-1AC	180	200	13.5	114.3	80	3	18	35	M12x25	75	60	38	10	289.5	240	-	359	310	44.5	184	149	34	34

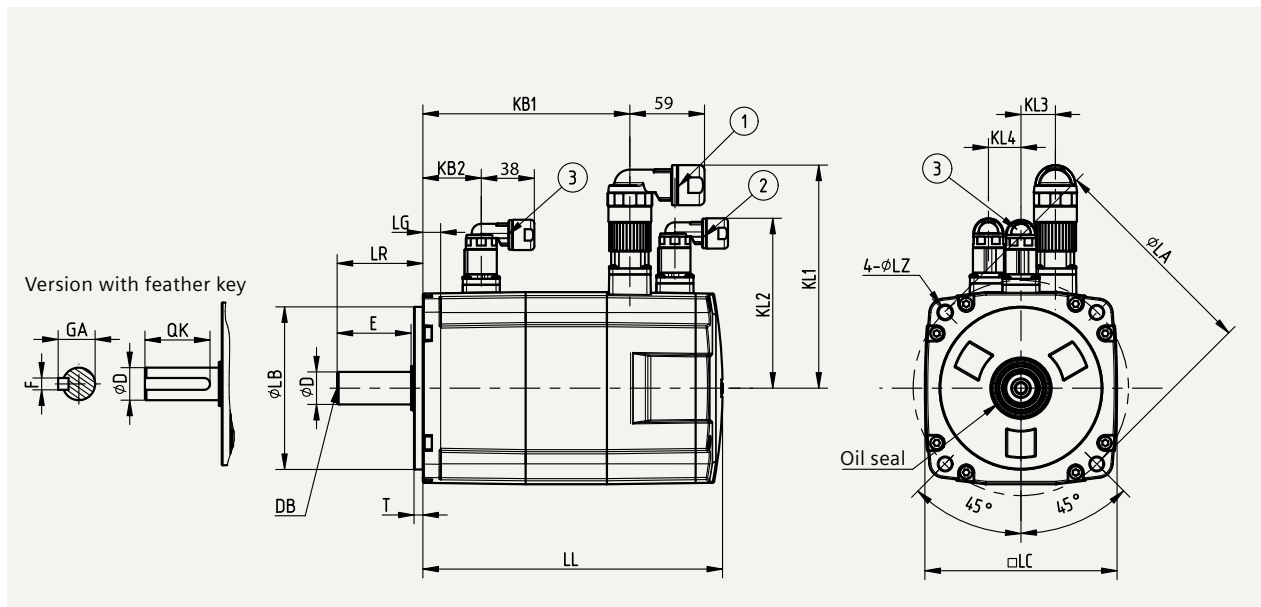

Note: ① Power connector, ② Incremental encoder connector, ③ Brake connector
Connectors should be ordered separately, for ordering information please refer to section "Options" in this document.

Outline dimensions of ② incremental encoder connector ③ brake connector are the same.

Shaft height 90 motor has M8 screws for eyebolts.

SIMOTICS S-1FL6 High Inertia

Dimension drawings (mm) SIMOTICS S-1FL6 High Inertia servomotors with absolute encoder

Shaft height	Type														Without brake			With brake						
		LC	LA	LZ	LB	LR	T	LG	D	DB	E	QK	GA	F	LL	KB1	KB2	LL	KB1	KB2	KL1	KL2	KL3	KL4
45	1FL6042-1AF	90	100	7	80	35	4	10	19	M6x16	30	25	21.5	6	157	100	-	203.5	147	31.5	136	60	-	-
	1FL6044-1AF	90	100	7	80	35	4	10	19	M6x16	30	25	21.5	6	204	147	-	250.5	194	31.5	136	60	-	-
65	1FL6061-1AC	130	145	9	110	58	6	12	22	M8x16	50	44	25	8	151	92	-	205.5	147	39.5	158	60	-	-
	1FL6062-1AC	130	145	9	110	58	6	12	22	M8x16	50	44	25	8	184	125	-	238.5	180	39.5	158	60	-	-
	1FL6064-1AC	130	145	9	110	58	6	12	22	M8x16	50	44	25	8	184	125	-	238.5	180	39.5	158	60	-	-
	1FL6066-1AC	130	145	9	110	58	6	12	22	M8x16	50	44	25	8	217	158	-	271.5	213	39.5	158	60	-	-
	1FL6067-1AC	130	145	9	110	58	6	12	22	M8x16	50	44	25	8	250	191	-	304.5	246	39.5	158	60	-	-
90	1FL6090-1AC	180	200	13.5	114.3	80	3	18	35	M12x25	75	60	38	10	197	135	-	263	201	44.5	184	60	-	-
	1FL6092-1AC	180	200	13.5	114.3	80	3	18	35	M12x25	75	60	38	10	223	161	-	289	227	44.5	184	60	-	-
	1FL6094-1AC	180	200	13.5	114.3	80	3	18	35	M12x25	75	60	38	10	249	187	-	315	253	44.5	184	60	-	-
	1FL6096-1AC	180	200	13.5	114.3	80	3	18	35	M12x25	75	60	38	10	301	239	-	367	305	44.5	184	60	-	-

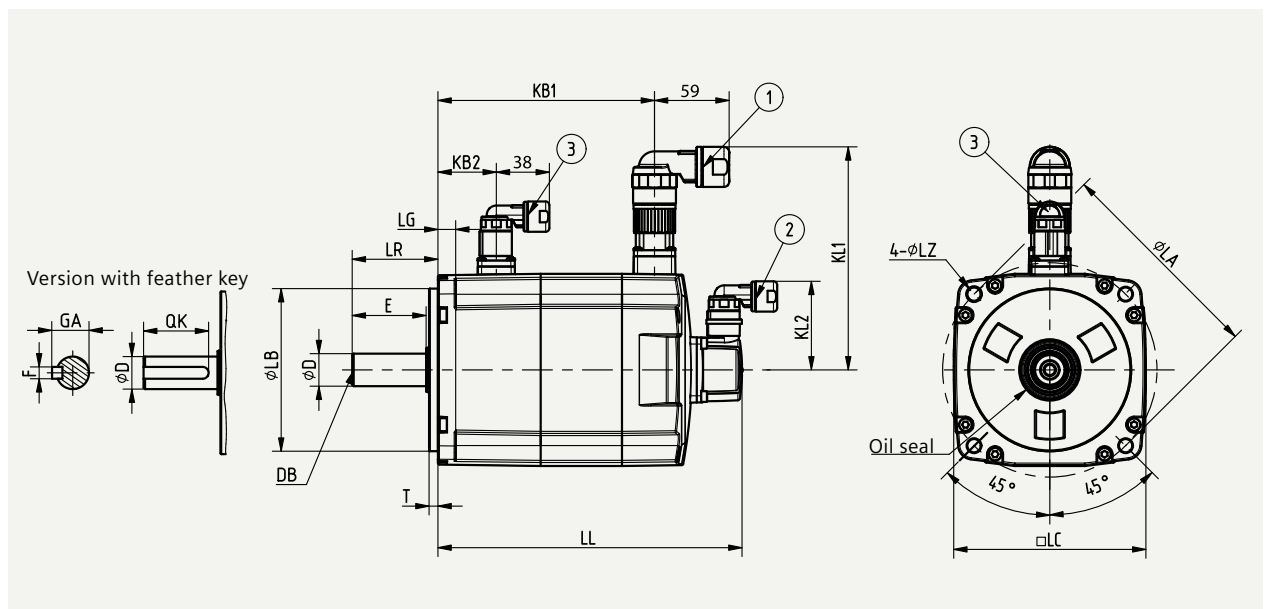

Note: ① Power connector, ② Absolute encoder connector, ③ Brake connector
 Connectors should be ordered separately, for ordering information please refer to section "Options" in this document.
 Outline dimensions of ② absolute encoder connector ③ brake connector are the same.
 Shaft height 90 motor has M8 screws for eyebolts.

There's more to it:
siemens.com/ids

**Discover in detail how
Integrated Drive Systems boost
your competitive edge and
improve your time to profit.**

Integrated
Drive Systems
to go: Visit our
mobile site!



Follow us on:
www.twitter.com/siemensindustry
www.youtube.com/siemens

**Published by
Siemens AG 2016**

Digital Factory
P.O. Box 3180
91050 Erlangen, Germany

Article No. E20001-A280-P670-V3-7600
Printed in Germany
Dispo 21500
WÜ/79794 WS 04168.0

Subject to changes and errors.
The information given in this document
only contains general descriptions and/or
performance features which may not
always specifically reflect those described,
or which may undergo modification in
the course of further development of
the products. The requested performance
features are binding only when they are
expressly agreed upon in the concluded
contract.

For the secure operation of Siemens
products and solutions, it is necessary
to take suitable preventive action (e.g.
cell protection concept) and integrate
each component into a holistic, state-
of-the-art industrial security concept.
Third-party products that may be in use
should also be considered.

For more information about industrial
security, visit
[http://www.siemens.com/
industrialsecurity](http://www.siemens.com/industrialsecurity)